

*AEP Model
UK Model
SCN Model*

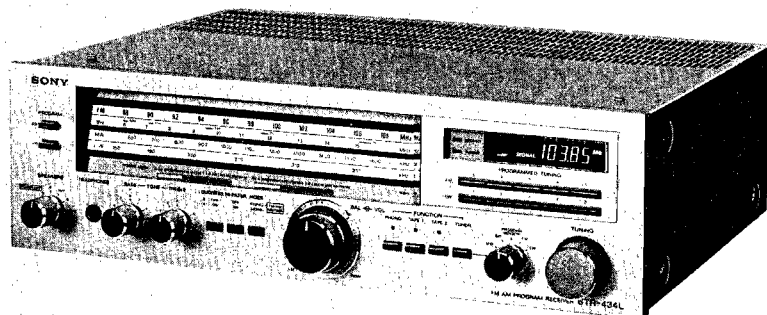

FM-AM PROGRAM RECEIVER

SPECIFICATIONS

GENERAL

- System:** Superheterodyne FM/AM tuner, Direct coupled pure-complementary symmetry power amplifier circuit (SEPP OTL)
- Power Requirements:** UK model: 240 V ac (or 220 V ac adjustable by authorized Sony personnel), 50 Hz
AEP, SCN model: 220 V ac (or 240 V ac adjustable by authorized Sony personnel), 50 Hz
- Power Consumption:** UK model: 380 W
AEP, SCN model: 290 W
- AC Outlets:** Two unswitched, total 200 W (not provided for SCN model)
- Dimensions:** Approx. 430 (w) x 135 (h) x 370 (d) mm
17 (w) x 5 1/4 (h) x 14 5/8 (d) inches including projecting parts and controls
- Weight:** Approx. 9.3 kg, 20 lb 9 oz (net)
Approx. 10.5 kg, 23 lb 3 oz (in shipping carton)

FM TUNER SECTION

- Tuning Range:** 87.5 – 108 MHz
- Antenna Terminals:** 300 Ω balanced
75 Ω unbalanced
- Intermediate Frequency:** 10.7 MHz
- Sensitivity at 50dB Quieting:** 3.5 μ V, 16.1 dB (mono)
45 μ V, 38.3 dBf (stereo)
- Sensitivity at 46dB Quieting:** 4.0 μ V (mono)
50 μ V (stereo)
(at 40kHz deviation)
- Usable Sensitivity:** IHF 1.8 μ V, 10.3 dBf
1.6 μ V (S/N = 26 dB, 40 kHz deviation)
- Signal-to-noise Ratio:** 75 dB (mono)
70 dB (stereo)
- Harmonic Distortion:** 0.15 % (mono)
0.3 % (stereo)
at 1 kHz
- IM Distortion:** 0.15 % (mono)
0.3 % (stereo)

SAFETY-RELATED COMPONENT WARNING!!

COMPONENTS IDENTIFIED BY SHADING AND MARK  ON THE SCHEMATIC DIAGRAMS, EXPLODED VIEWS AND IN THE PARTS LIST ARE CRITICAL TO SAFE OPERATION. REPLACE THESE COMPONENTS WITH SONY PARTS WHOSE PART NUMBERS APPEAR AS SHOWN IN THIS MANUAL OR IN SUPPLEMENTS PUBLISHED BY SONY.

— Continued on page 2 —

SONY[®]

SERVICE MANUAL

Separation: 45 dB at 1 kHz
Frequency Response: 40 Hz – 12.5 kHz ± 0.5 dB (DIN)
 30 Hz – 15 kHz ± 0.5 dB (IHF)
Selectivity at 300kHz: 55 dB
 (at 40kHz deviation,
 S/N = 26dB)
Capture Ratio: 1.0 dB
AM Suppression Ratio: 54 dB
Image Response Ratio: 75 dB
Spurious Response Ratio: 75 dB
Muting Threshold: Approx. 5 μ V

SW/MW/LW TUNER SECTION

	SW	MW	LW
Tuning range	5.8 MHz – 15.8 MHz	522 kHz – 1,602 kHz	150 kHz – 350 kHz
Antenna	External antenna terminal	Built-in ferrite rod antenna, External antenna terminal	
Intermediate frequency	450 kHz		
Usable sensitivity	30 μ V, external antenna (10 MHz)	250 μ V/m, built-in antenna (1,000 kHz) 100 μ V, external antenna (1,000 kHz)	500 μ V/m, built-in antenna (230 kHz) 100 μ V, external antenna (230 kHz)
Signal-to noise ratio	52 dB (5 mV)	52 dB (50 mV/m)	52 dB (50 mV/m)
Harmonic distortion	0.3 % (5 mV, 400 Hz)	0.3 % (50 mV/m, 400 Hz)	0.3 % (50 mV/m, 400 Hz)
Selectivity	50 dB (9 kHz)	50 dB (9 kHz)	50 dB (9 kHz)

AMPLIFIER SECTION

Continuous RMS Power Output: at 20 Hz – 20 kHz
 (less than 0.08% THD, both channels driven simultaneously) at 1 kHz
 40 + 40 W (8 Ω)
 40 + 40 W (4 Ω)
 43 + 43 W (8 Ω)
 43 + 43 W (4 Ω)
 according to DIN 45500
 40 + 40 W (8 Ω)
 40 + 40 W (4 Ω)

Dynamic Power Output: 130 W (8 Ω)
 (IHF constant power supply method) 130 W (4 Ω)

Power Bandwidth (IHF): 10 Hz – 40 kHz

Damping Factor: 20 at 1 kHz, 8 Ω

Harmonic Distortion: Less than 0.08 % at rated output
 Less than 0.08 % at 1 W output

Intermodulation (IM) Distortion: Less than 0.08 % at rated output
 (60Hz : 7kHz = 4 : 1) Less than 0.08 % at 1 W output

Residual Noise: Less than 0.08 μ W at 8 Ω

Inputs:

	Sensitivity	Impedance	S/N	Weighting network
PHONO	2.5 mV	50 k Ω	80 dB	A
TAPE 1, 2	150 mV	100 k Ω	95 dB	A

Measured with rated output power into 8 Ω loads (both channels driven simultaneously) at 1 kHz.

Outputs (with rated input):

REC OUT 1, 2	Voltage 150 mV Impedance 10 k Ω
HEADPHONES	Accepts all low or high impedance headphones.
SPEAKER	4 – 16 Ω speakers are suitable.

Frequency Response: PHONO
 RIAA equalization curve ± 0.5 dB
 TAPE 1, 2

10 Hz – 50 kHz ± 1 dB
 -3 dB

Tone Controls: BASS ± 10 dB at 100 Hz
 TREBLE ± 10 dB at 10 kHz

High Filter: 6 dB/oct. above 7.5 kHz

Loudness Control: +6 dB at 100 Hz
 (att. 30dB) +3 dB at 10 kHz

MODEL IDENTIFICATION

– Print on Rear Panel –

SONY [®]	FM-AM PROGRAM RECEIVER
	MODEL NO. STR-434L
	FREQ. RANGE : FM 87.5 - 108MHz SW 5.8 - 15.8MHz MW 522 - 1602KHz LW 150 - 350KHz
	IF : FM 10.7MHz AM 450KHz
	MADE IN JAPAN
SERIAL NO.	

<i>UK MODEL</i>	<i>AC 240V ~50Hz</i>	<i>380W</i>
<i>AEP MODEL</i>	<i>AC 220V ~50Hz</i>	<i>290W</i>
<i>SCN MODEL</i>		

– AC Outlet –

SCN model has no ac outlet.

STR-434L STR-434L

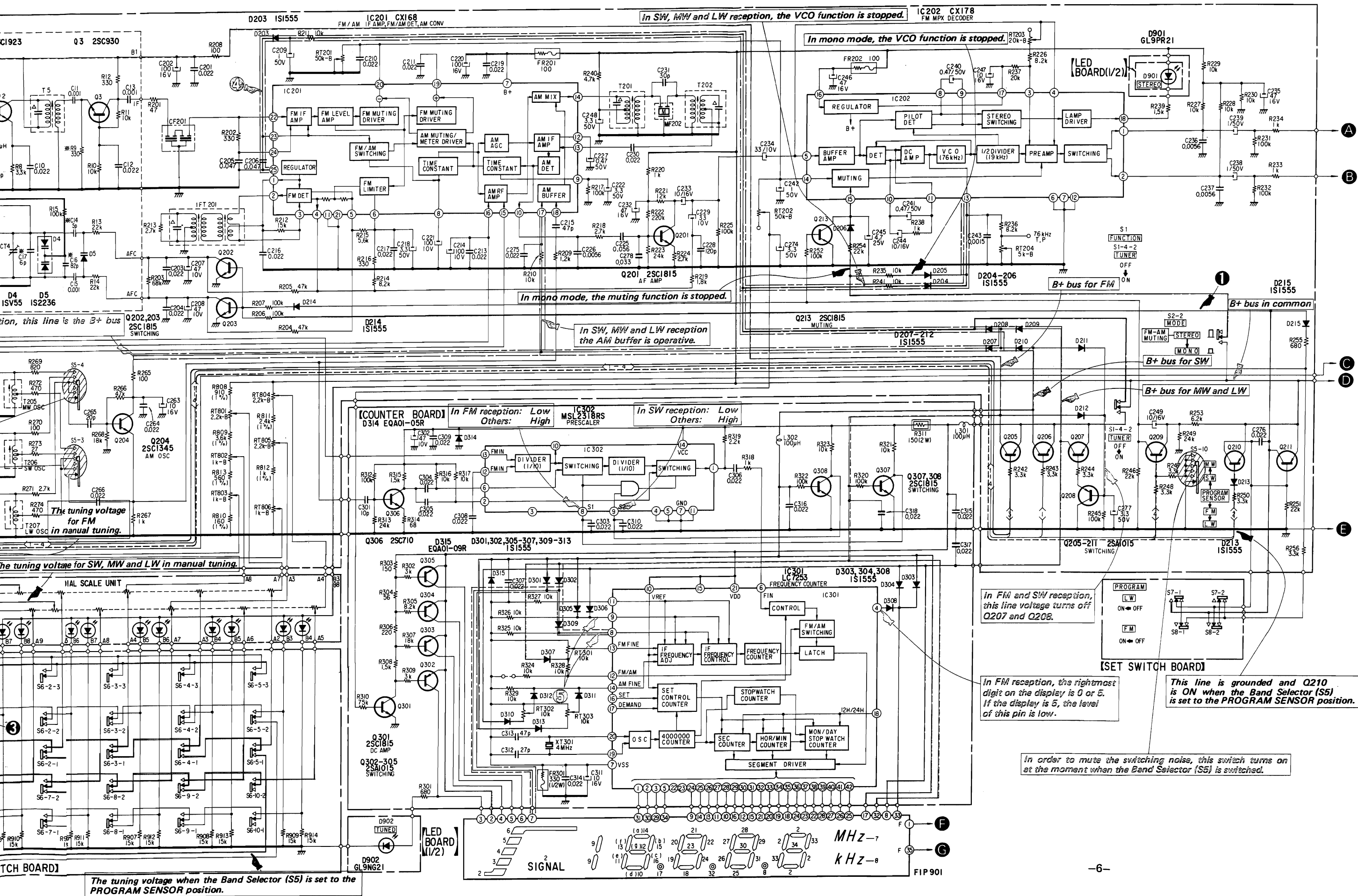

In SW, MW and LW reception, the VCO function is stopped.

In mono mode, the VCO function is stopped.

In mono mode, the muting function is stopped.

In SW, MW and LW reception the AM buffer is operative.

In FM reception: Low Others: High

In SW reception: Low Others: High

In FM and SW reception, this line voltage turns off Q207 and Q208.

In FM reception, the rightmost digit on the display is 0 or 5. If the display is 5, the level of this pin is low.

In order to mute the switching noise, this switch turns on at the moment when the Band Selector (S5) is switched.

1-2. BLOCK DIAGRAM

- ① While keeping the FM PROGRAM button depressed, the voltage supplied to this line turns Q203 and Q202 on, and suspends the AFC function.
- ② When the Band Selector (S5) is set to the PROGRAM SENSOR position, a selection of LW or FM mode is done by connecting the B+ bus to the respective circuit.
- ③ When one of the preset switches (S6-1 to S6-10) is pressed, this line level becomes high so that Q209 turns off and the muting circuit is cut off. When all of the preset switches are OFF, Q209 is ON and the muting circuit is active since this line is grounded via R915 and D908.
- ④ In SW, MW and LW reception, the CX168 function is switched to AM mode.
- ⑤ The counter function is switched by this line voltage, depending on the IF frequency either FM IF freq. or AM IF freq.

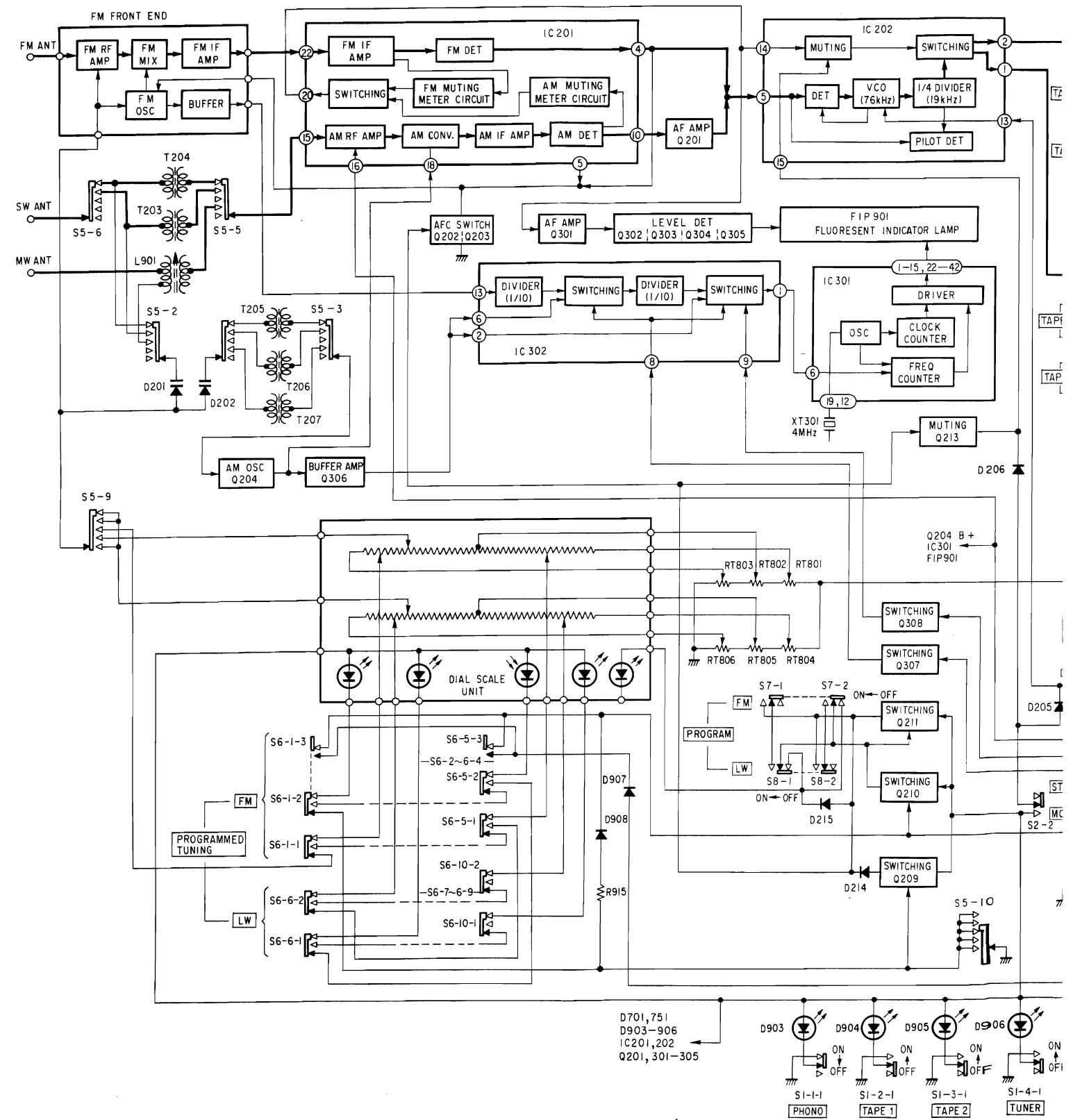

SECTION 2
DISASSEMBLY

• Follow the disassembly procedure in the numerical order given.

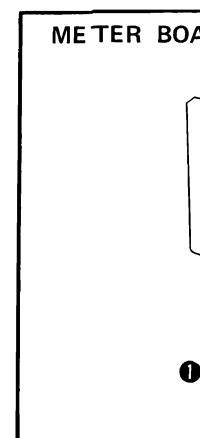
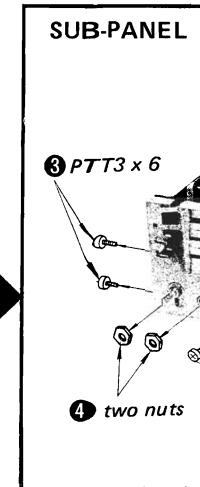
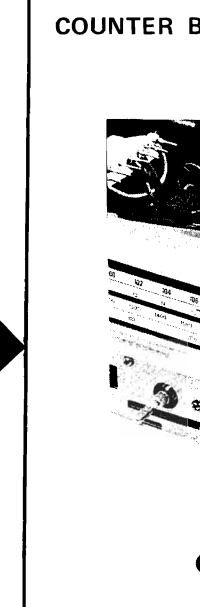
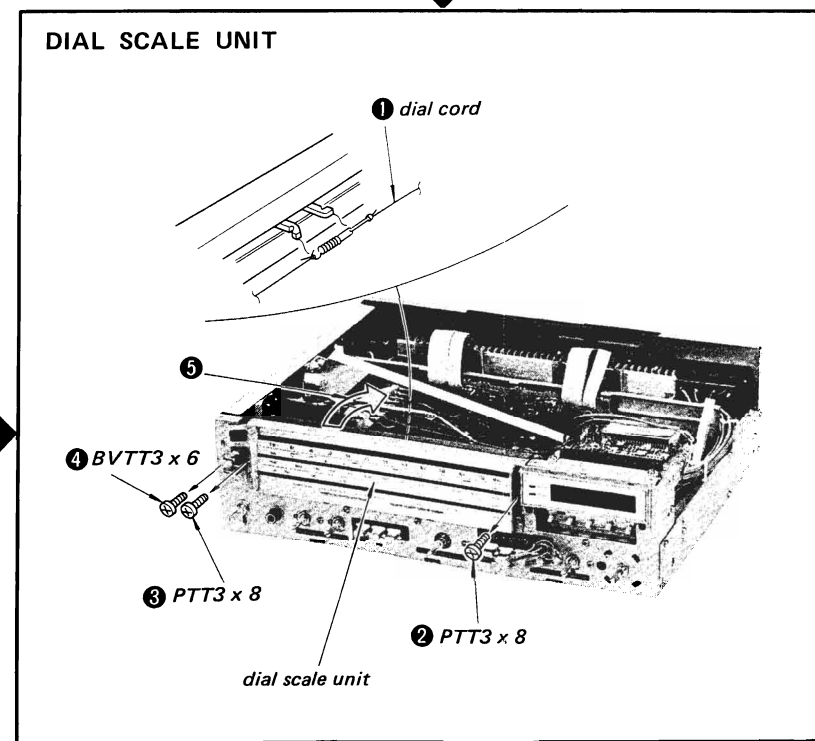
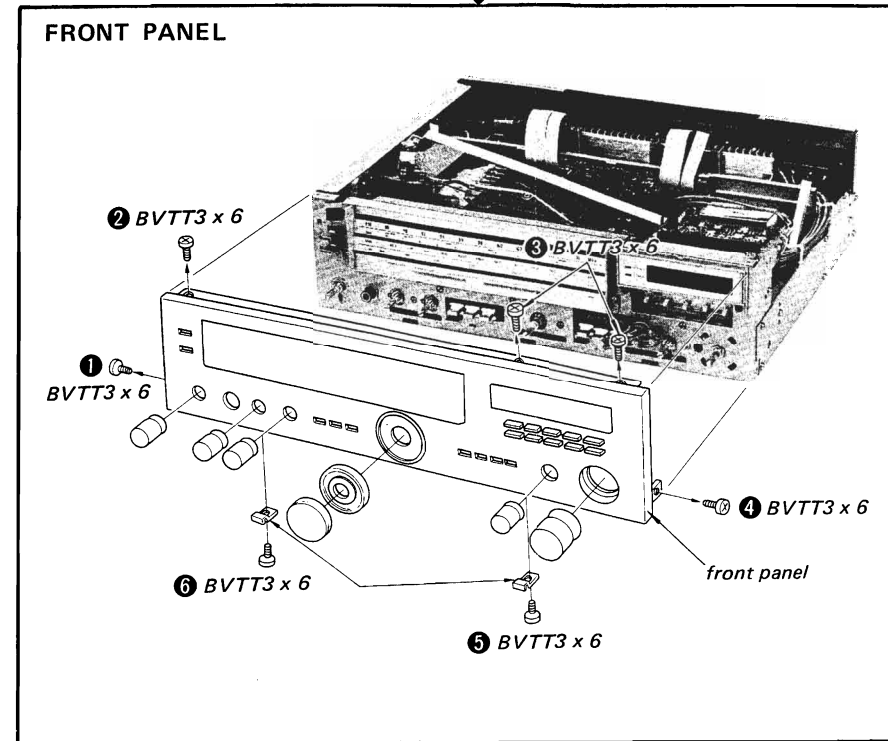
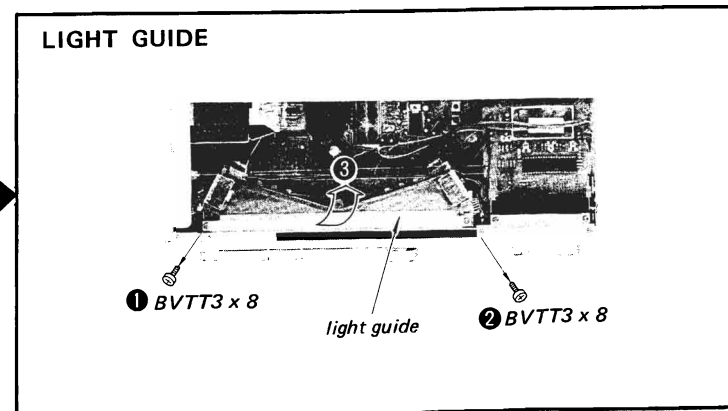
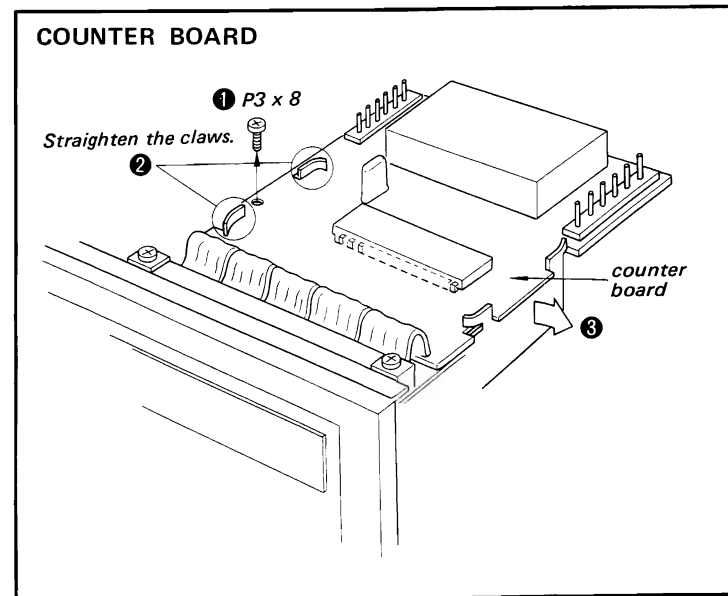
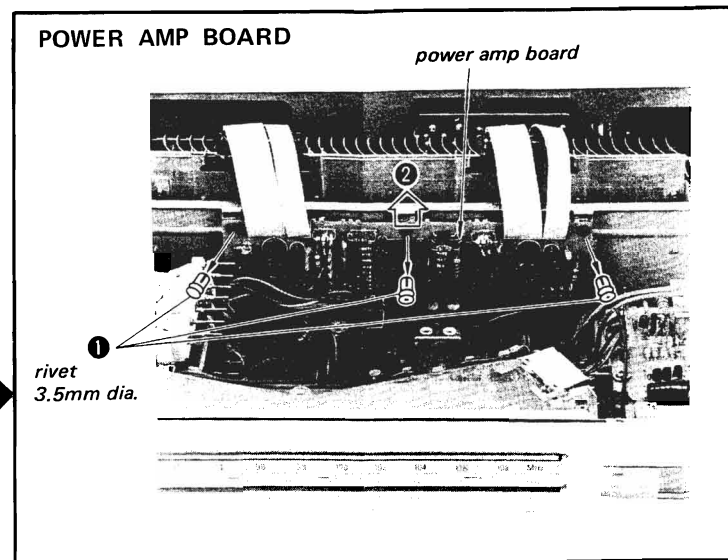
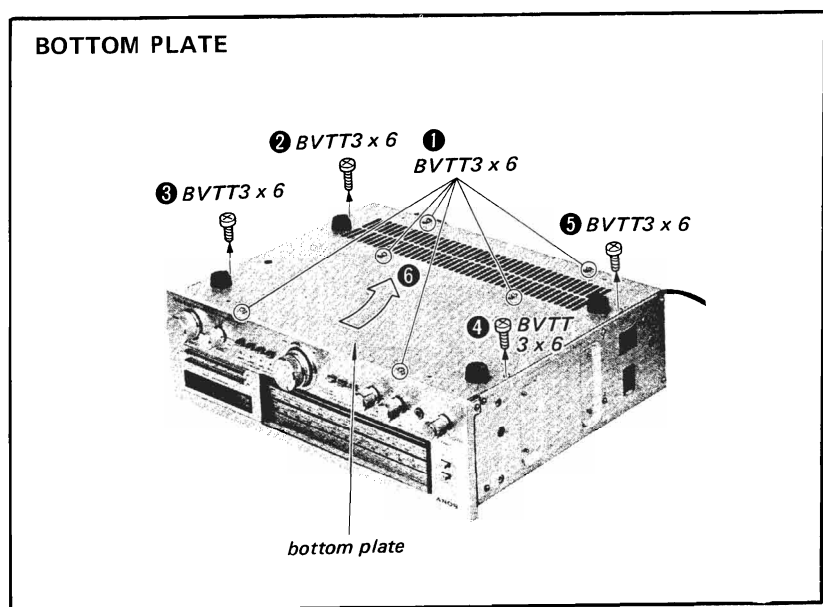
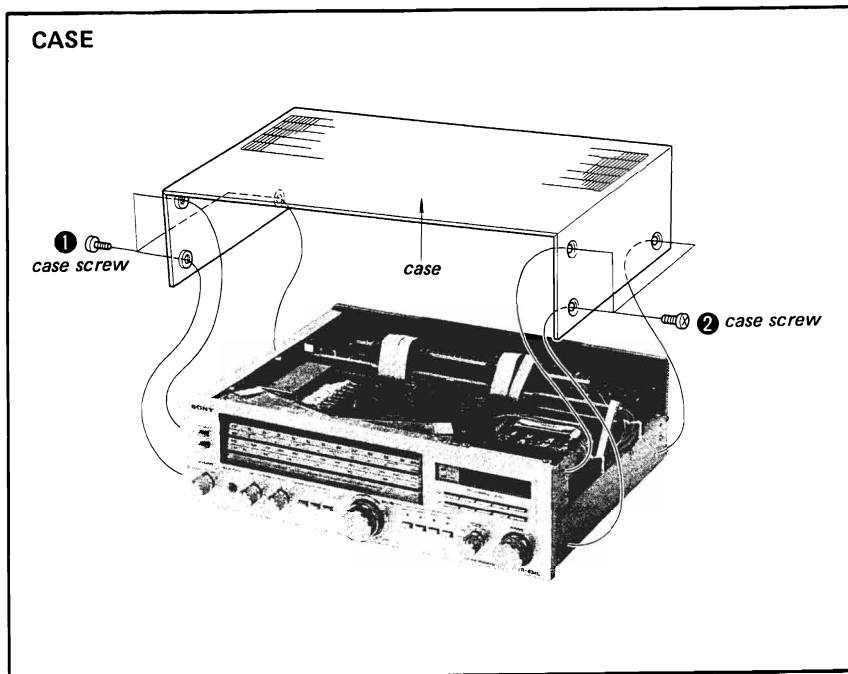

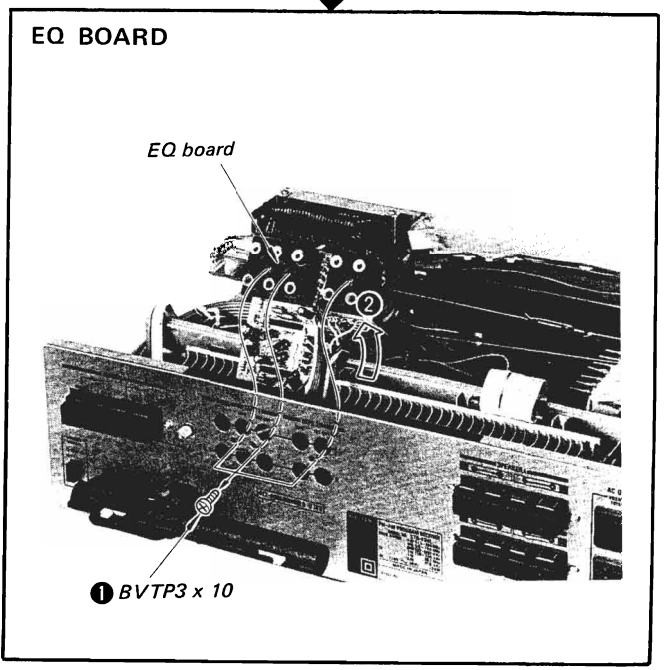
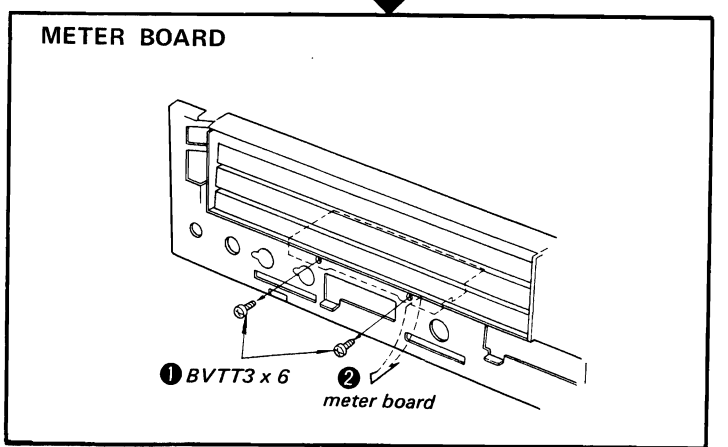
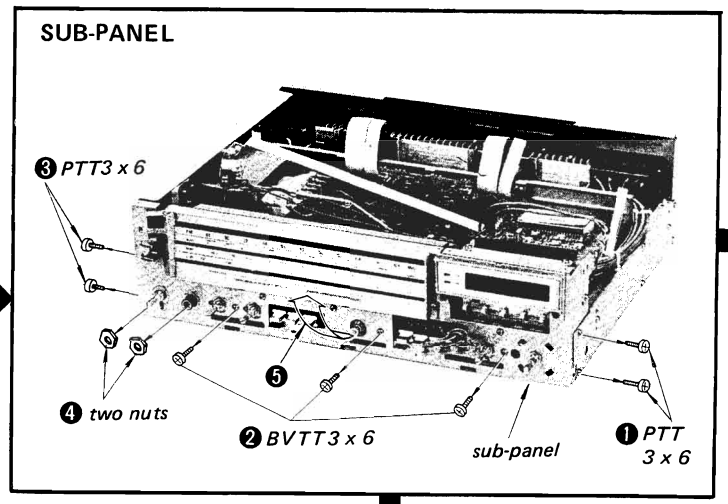
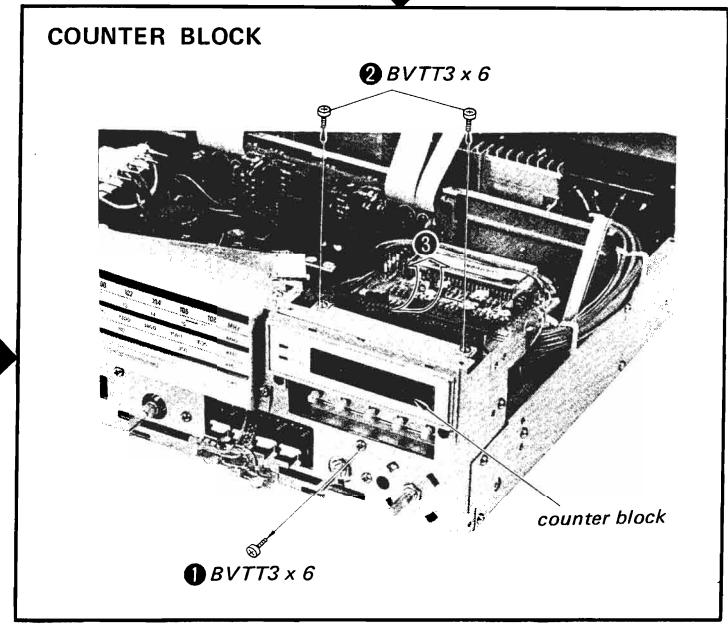
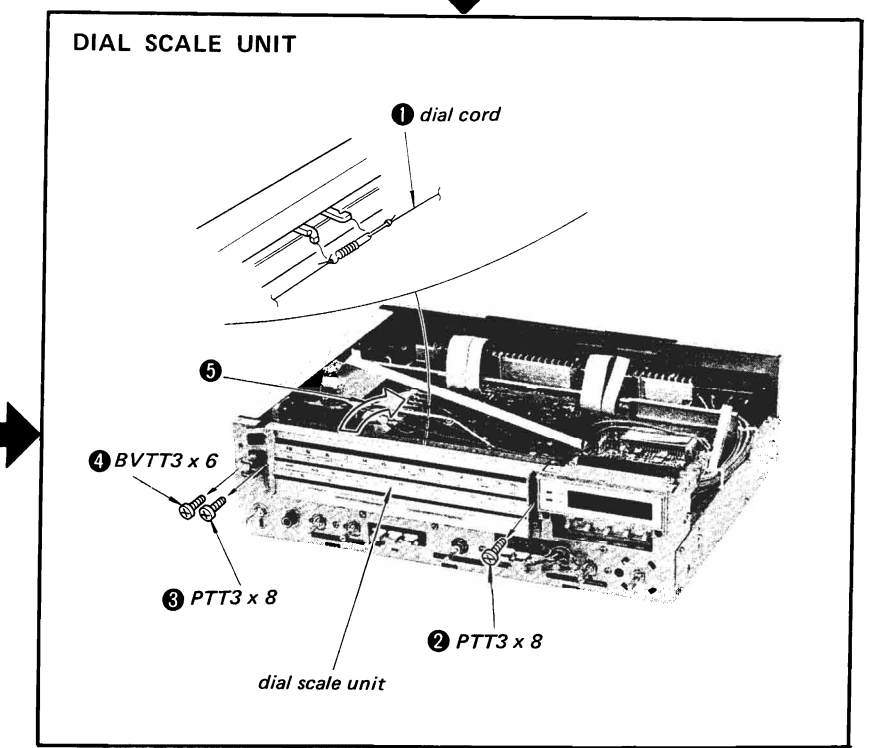
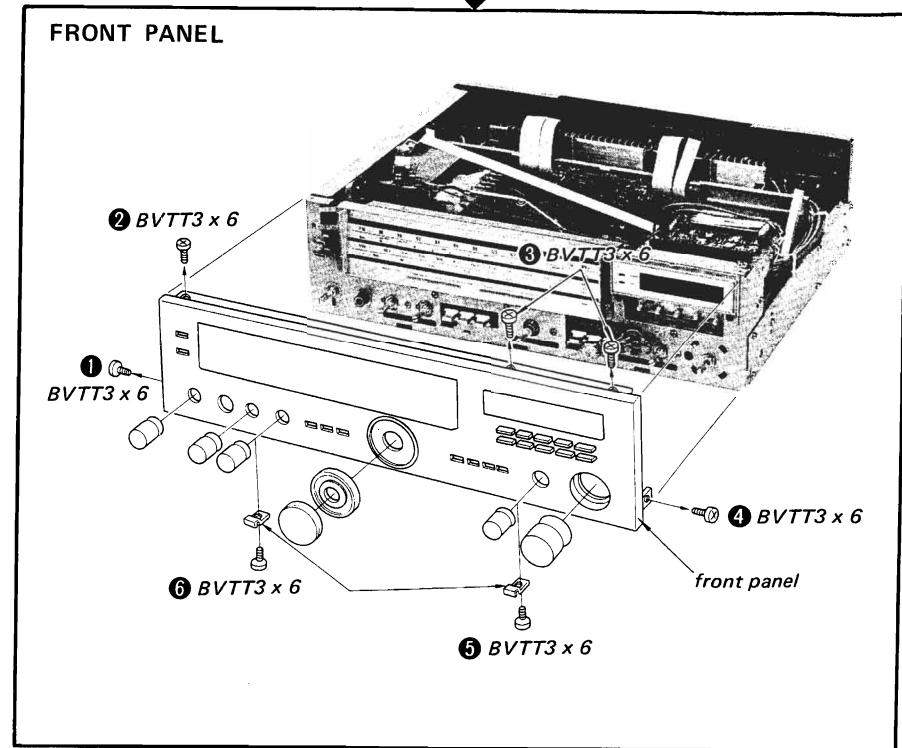
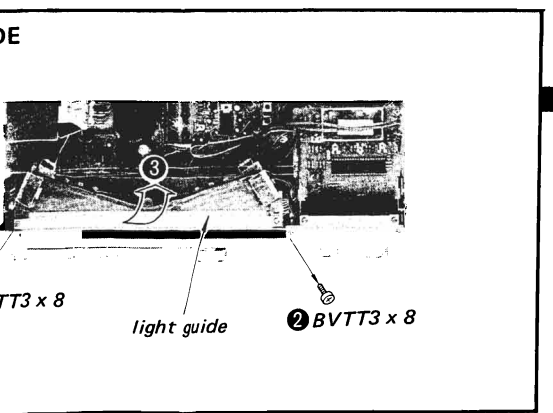
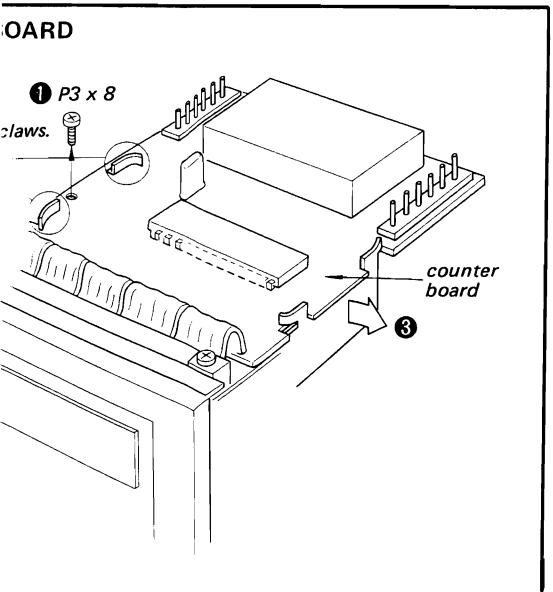

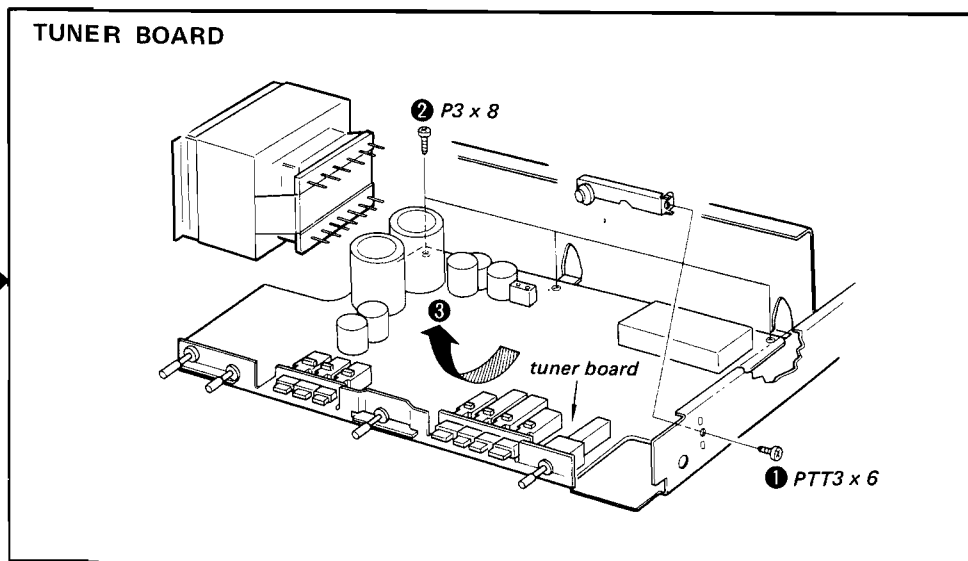
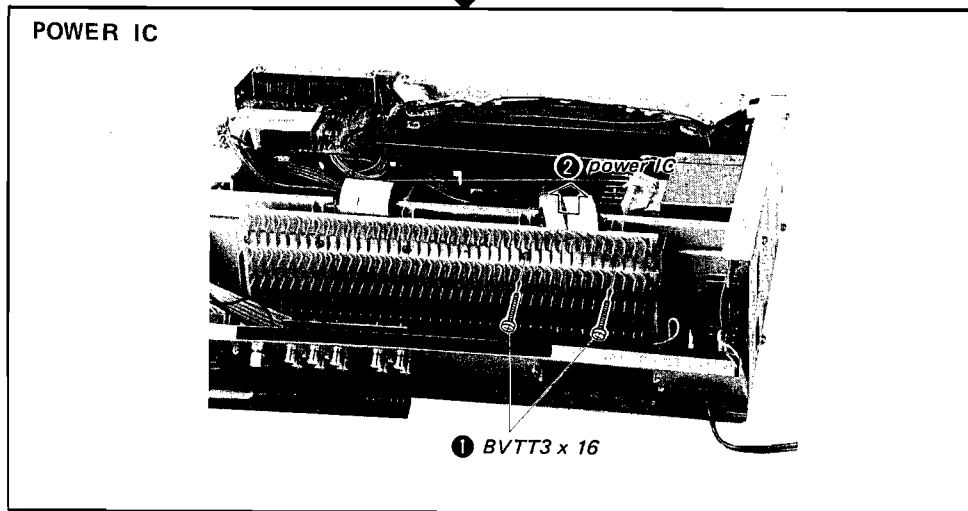
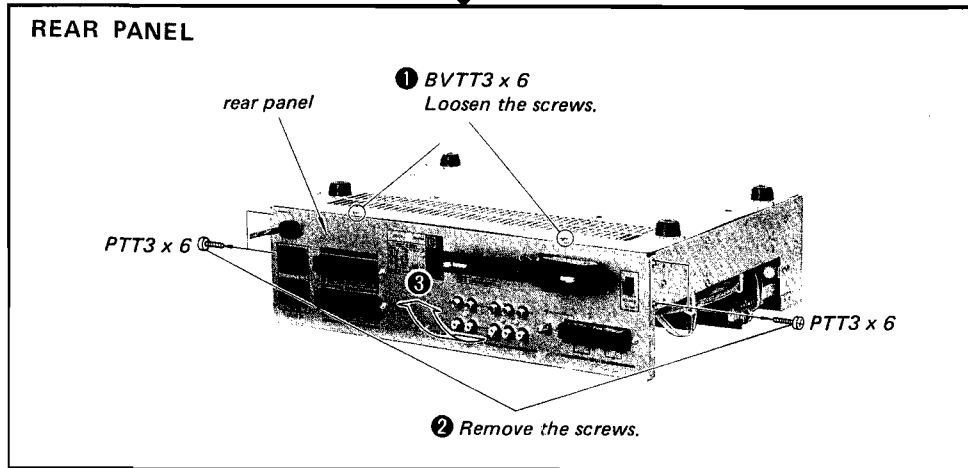

DIAL SCALE UNIT

This unit is tuned by moving the sliders of the dial scale unit along the carbon-coated lines of the resistor plates. The sliders should be moved very precisely. So, carefully perform the disassembly and the installation of the dial scale unit as follows. Only the marker and the pointer table are replaceable.

Take care not to damage the sliders shown below.

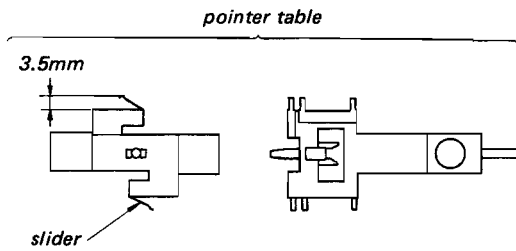
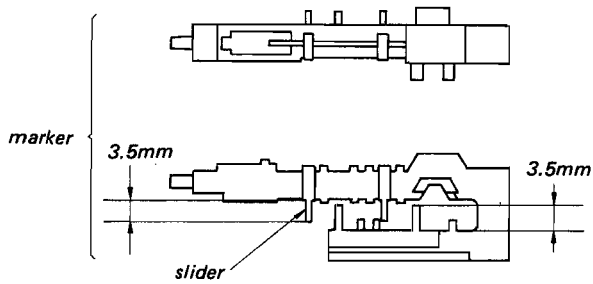

• **Dial Scale Unit Disassembly**

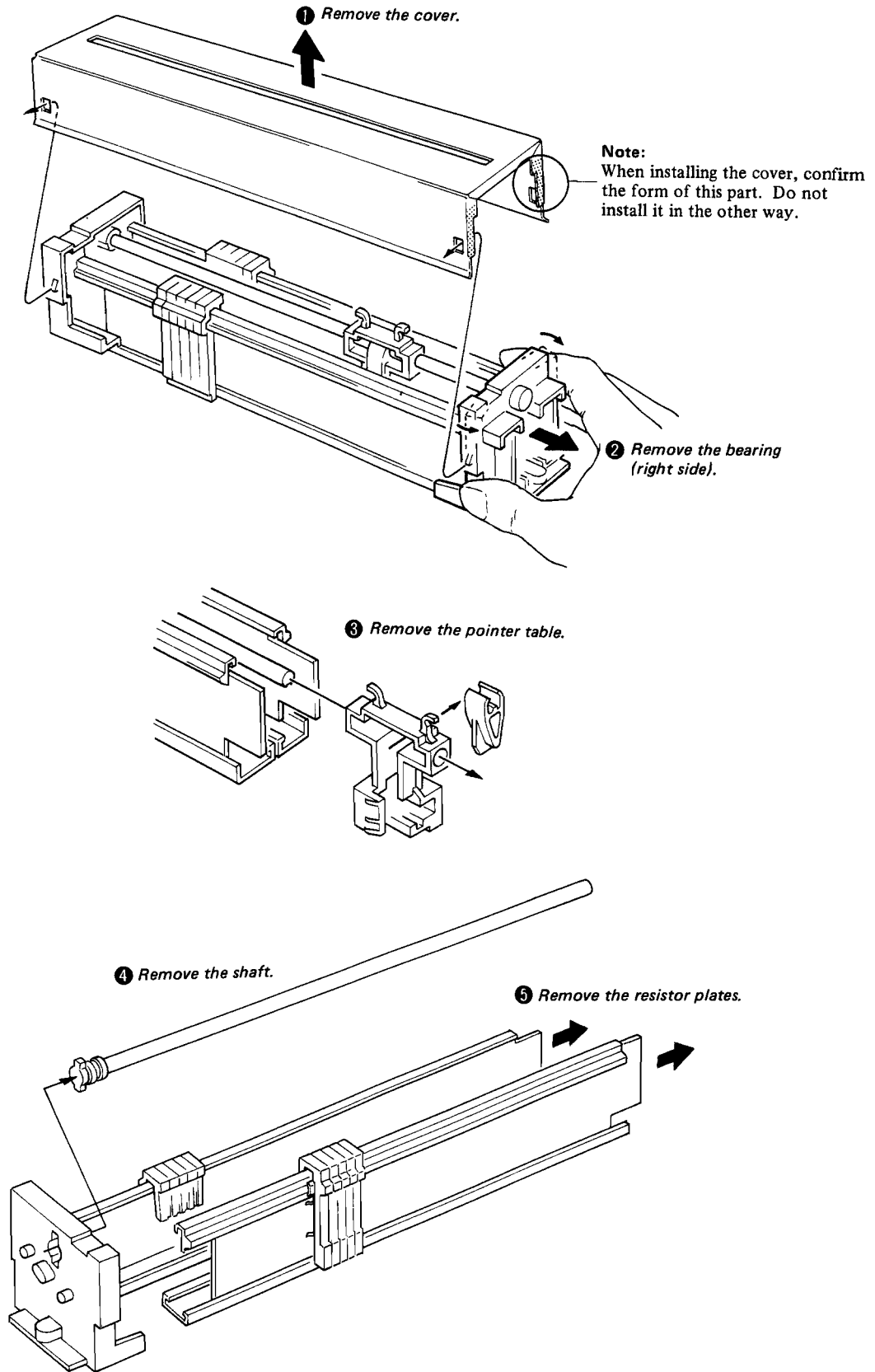

• Dial Scale Unit Installation

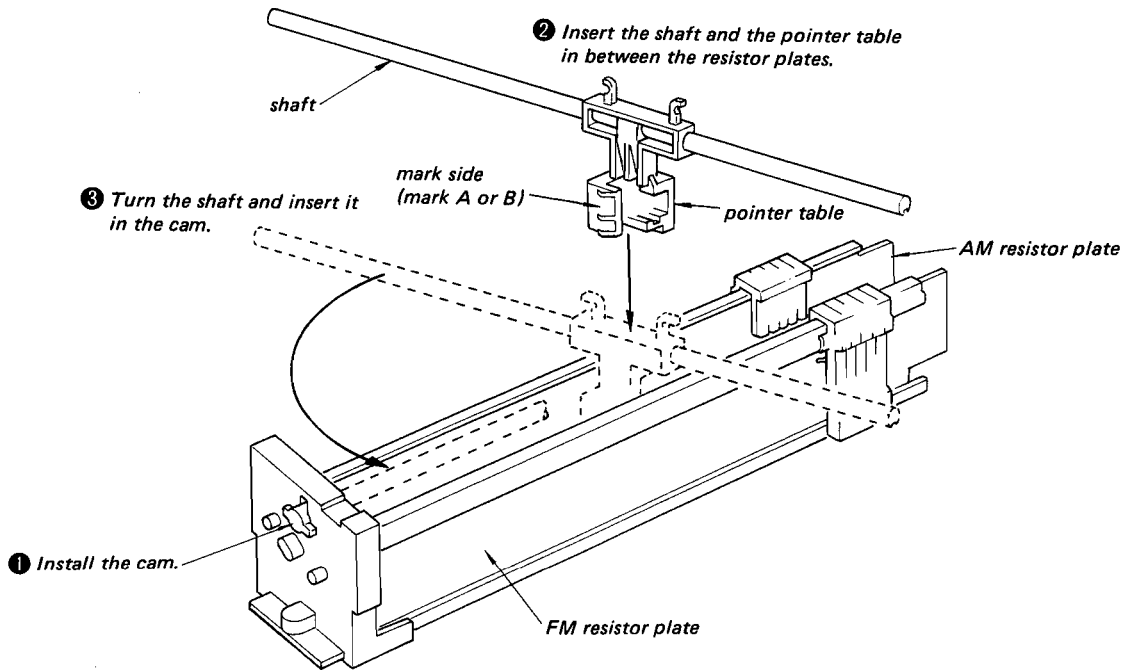

Note:
The installation is performed in this way not to damage the sliders of the pointer table.

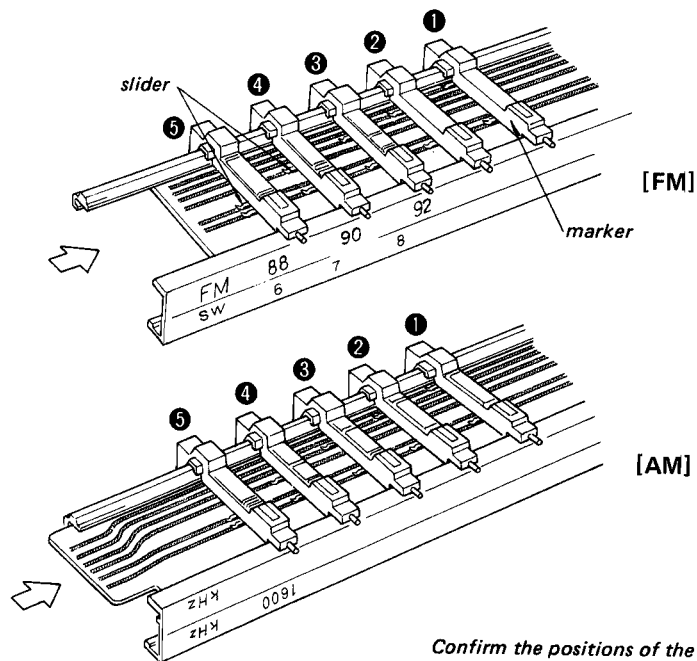

Confirm the positions of the sliders and install the markers in the numerical order given. If one of the markers is damaged, replace the five markers together to obtain the same brightness of them.

DIAL CORD STRINGING

Note:
 Before the dial cord stringing, remove the counter board referring to the pages 10 and 11.

1 Remove the counter board.
 Prepare a dial cord [0.5mm dia.,
 1100mm (43 3/8 inches)].

5 Remove the pulley bracket.

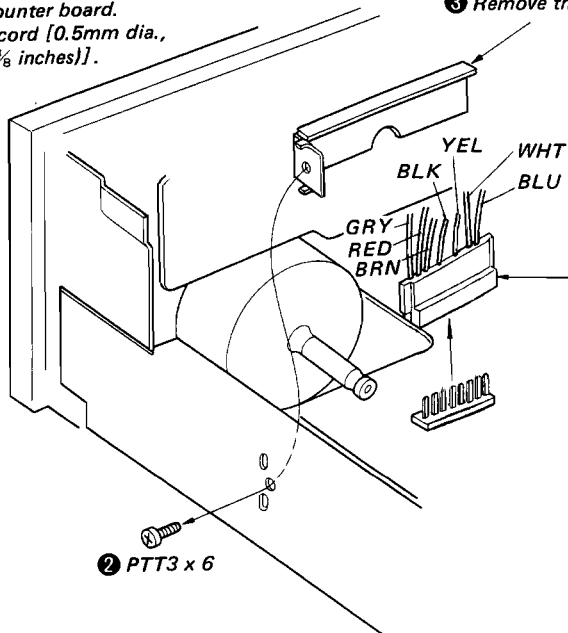

4 Disconnect the connector.

15 Install the pulley bracket and plug in the connector.

2 PTT3 x 6

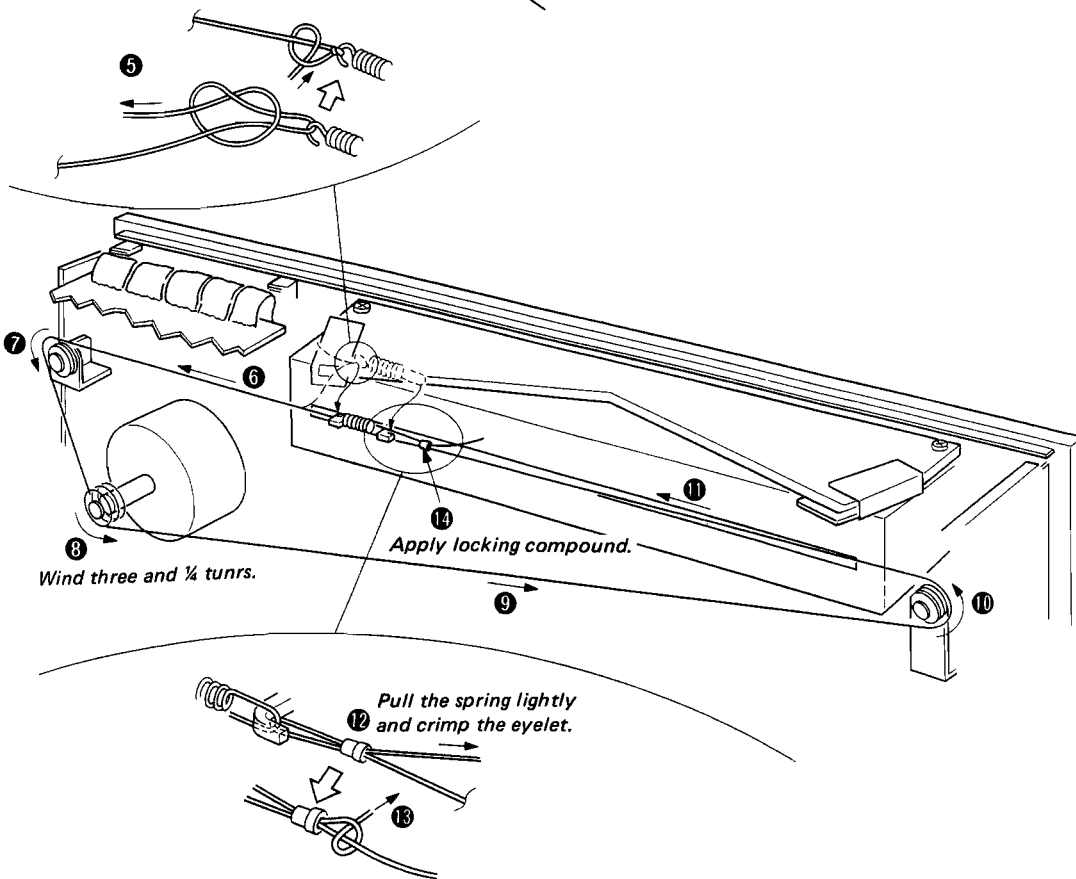

8 Wind three and 1/4 turns.

14 Apply locking compound.

12 Pull the spring lightly and crimp the eyelet.

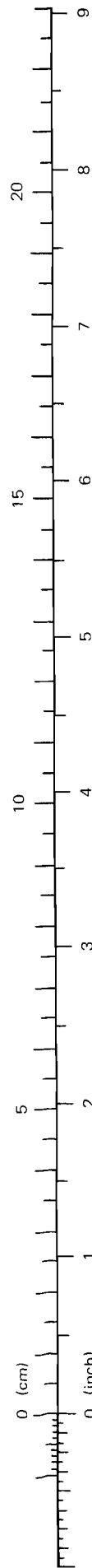

SECTION 3
ADJUSTMENTS

3-1. AM SECTION

Setting: FUNCTION switch: TUNER
 Band Selector switch: MW
 ANTENNA switch: BUILT IN

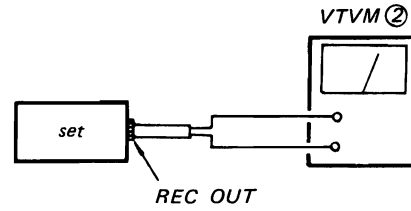
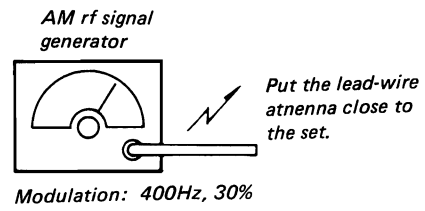

• Repeat the procedures in each adjustment several times, and the frequency coverage and tracking adjustments should be finally done by the trimmer capacitors.

AM IF ALIGNMENT	
Adjust for a maximum reading on VTVM ②.	
450kHz	
T202	T201

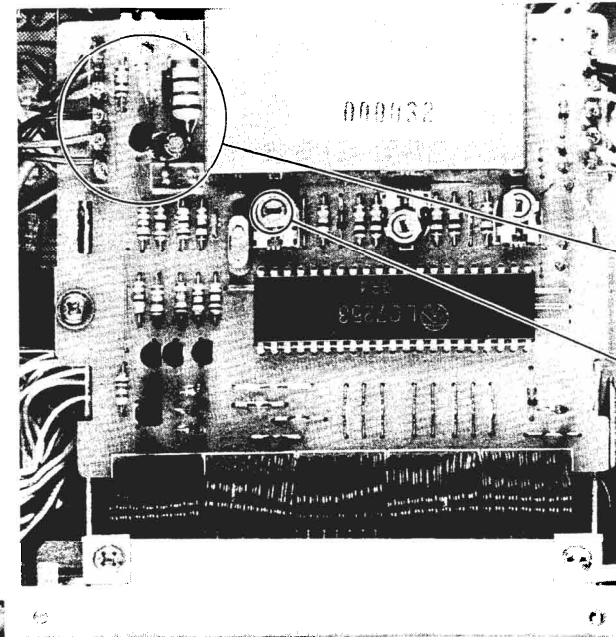

MW FREQUENCY INDICATION ADJUSTMENT
 Setting: AM Rf Signal Generator: 1000 kHz
 Procedure:

1. Set the Band Selector switch to the MW position and connect a 10kΩ carbon resistor as shown below.

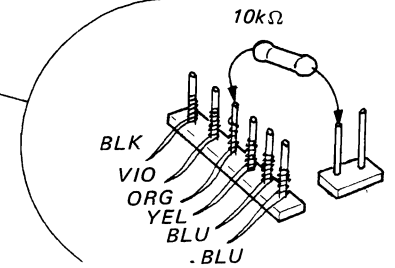

2. Tune the unit to the 1000.0kHz signal precisely and adjust RT302 so that the rightmost digit on the display stops flickering.

MW FREQUENCY COVERAGE ADJUSTMENT			
Tuning Control Voltage Adjustment	Dial Indication	VTVM ① Reading	Adjustment Part
	maximum frequency	25V	RT804
	minimum frequency	2V	RT806
Adjust for a specified reading on VTVM ①.			
Local Oscillator Frequency Adjustment	Dial Indication	AM Rf Signal Generator Frequency	Adjustment Part
	minimum frequency	515kHz	T205
	maximum frequency	1660kHz	CT204
Adjust for a maximum reading on VTVM ②.			
Dial Pointer Setting	Dial Indication	AM Rf Signal Generator Frequency	Adjustment Part
	600kHz	600kHz	RT804
	1000kHz	1000kHz	RT805
	1400kHz	1400kHz	RT806
Adjust for a maximum reading on VTVM ②.			
Note: Be sure to perform the LW and the SW frequency coverage adjustments after the tuning control voltage adjustment.			

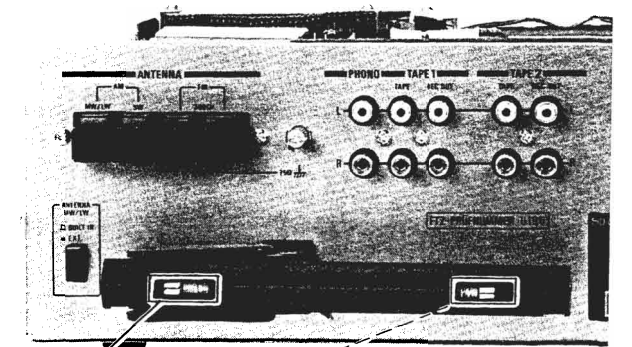
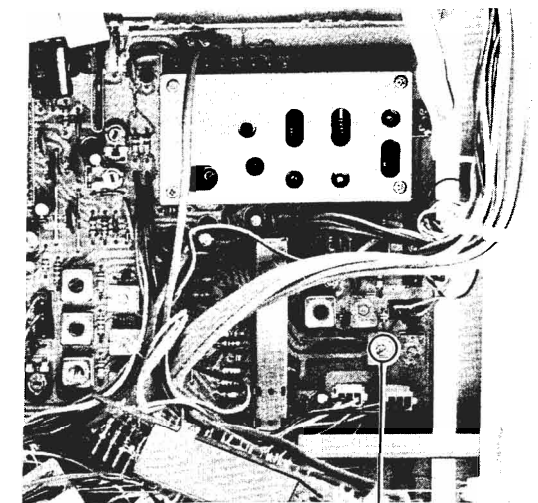
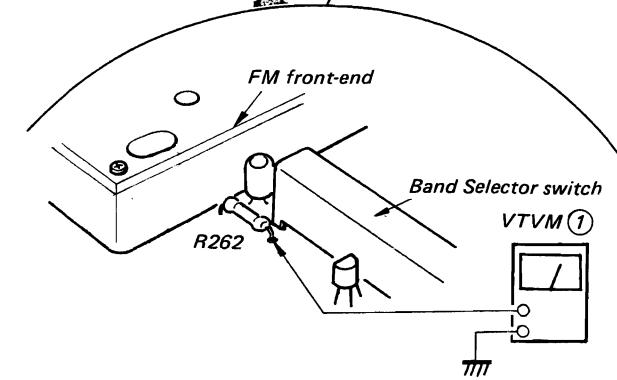
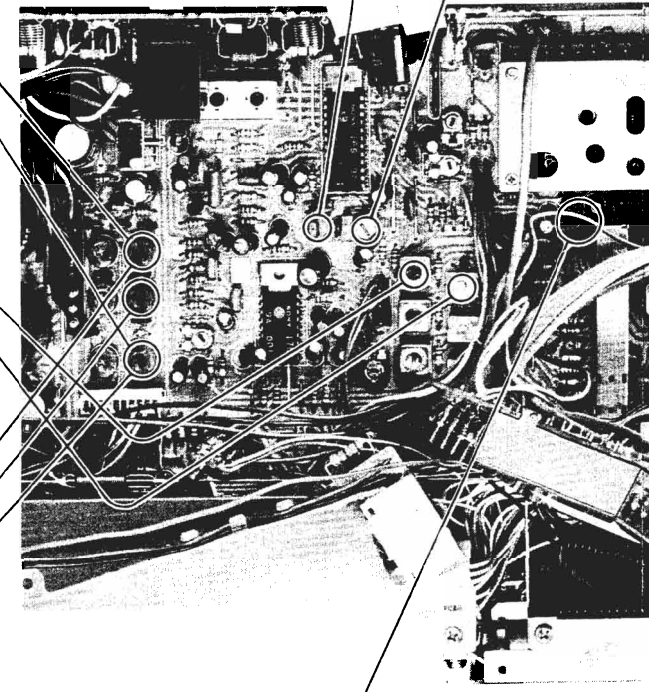

AEP model: Serial No. 501,001 and later
 AEP model: Serial No. 500,000 - 501,001
 US model
 SCN model

MW TRACKING ADJUSTMENT	
Adjust for a maximum reading on VTVM ②.	
L901-1	600kHz
CT201	1,400kHz

Setting: FUNCTION switch TUNER
 Band Selector switch: LW
 ANTENNA switch: BUILT IN

AM rf signal generator

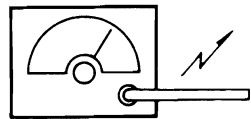

Put the lead-wire antenna close to the set.

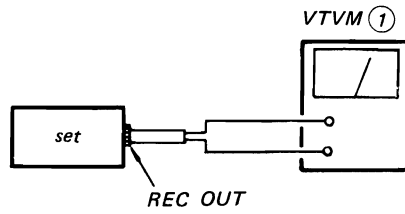

- Repeat the procedures in each adjustment several times, and the frequency coverage and tracking adjustments should be finally done by the trimmer capacitors.

MW/LW EXT ANTENNA COIL ADJUSTMENT

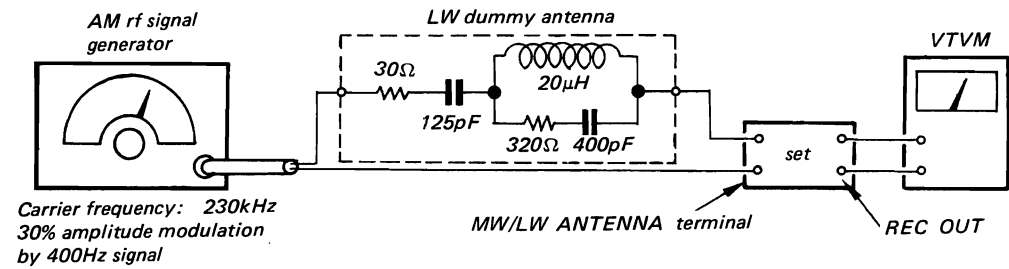

1. Set the ANTENNA switch to EXT position.
2. Tune the set to 230kHz and adjust T204 for a maximum reading on VTVM .

T204

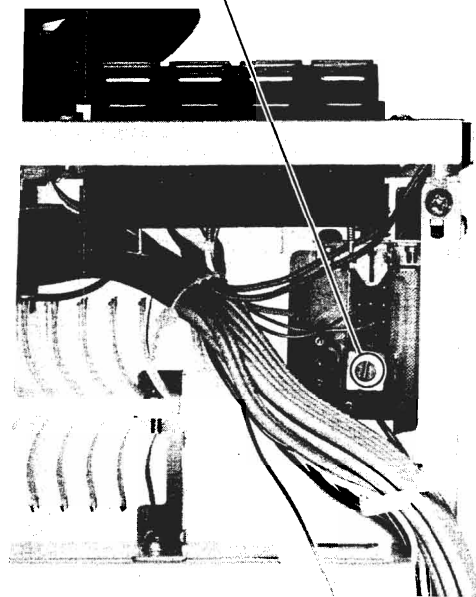

LW FREQUENCY COVERAGE ADJUSTMENT

Adjust for a maximum reading on VTVM ① .	
145kHz	T207
365kHz	CT206

Note: Before this adjustment, perform the MW frequency coverage adjustment.

AEP model: Serial No. 501,000 and later

AEP model: Serial No. 500,000 - 501,001
 UK model
 SCN model

L901-2	170kHz
CT203	310kHz
Adjust for a maximum reading on VTVM ① .	
LW TRACKING ADJUSTMENT	

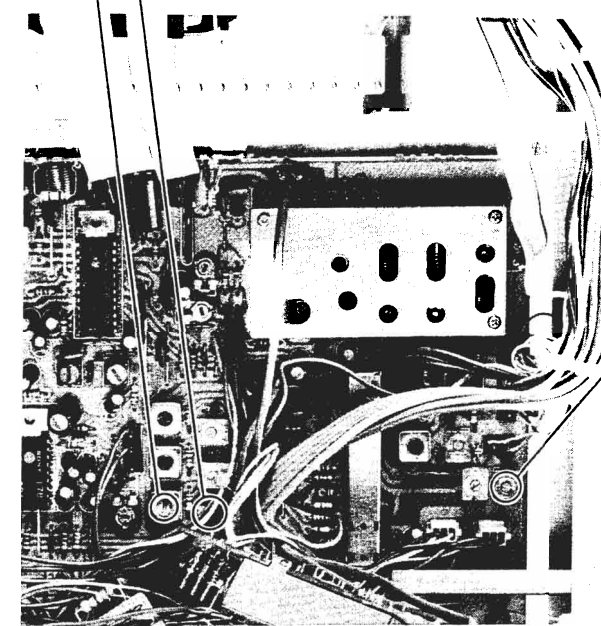
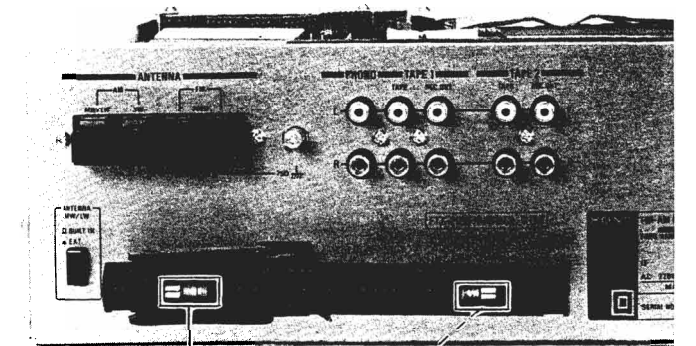

Setting: FUNCTION switch: TUNER
Band Selector switch: SW

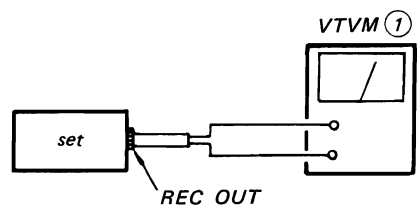
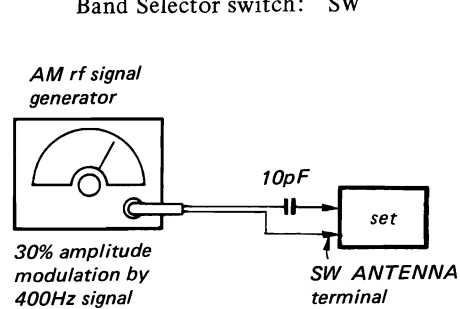

• Repeat the procedures in each adjustment several times, and the frequency coverage and tracking adjustments should be finally done by the trimmer capacitors.

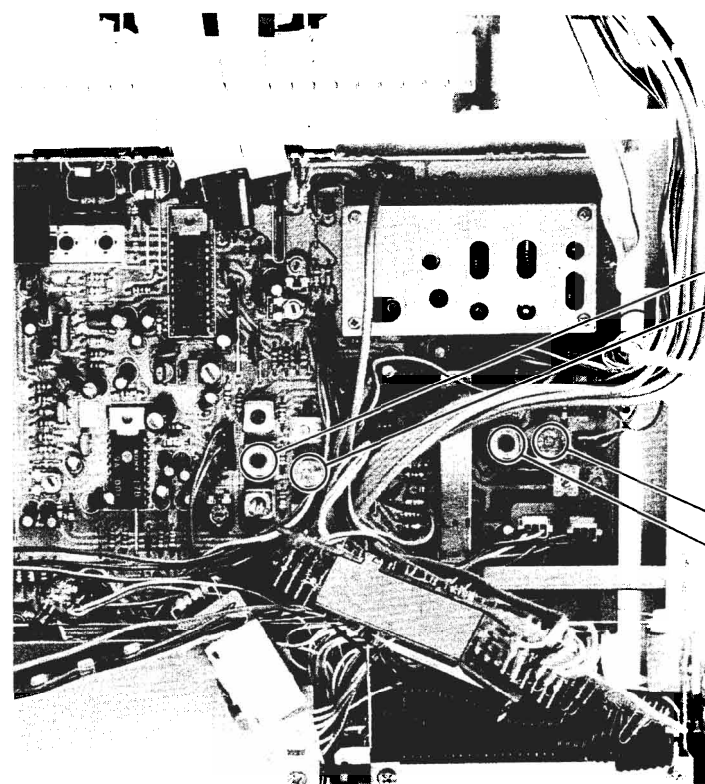

SW FREQUENCY COVERAGE ADJUSTMENT	
Adjust for a maximum reading on VTVM ①.	
T206	5.5MHz
CT205	16.1MHz

Note:
Before this adjustment, perform the MW frequency coverage adjustment.

SW TRACKING ADJUSTMENT	
Adjust for a maximum reading on VTVM ①.	
CT202	16.1MHz
T203	5.5MHz

SW FREQUENCY INDICATION ADJUSTMENT

Setting: AM Rf Signal Generator: 10,000 MHz

Procedure:

1. Set the Band Selector switch to the SW position and connect a 10kΩ carbon resistor as shown below.
2. Tune the unit to the 10.000MHz signal precisely and adjust RT303 so that the rightmost digit on the display stops flickering.

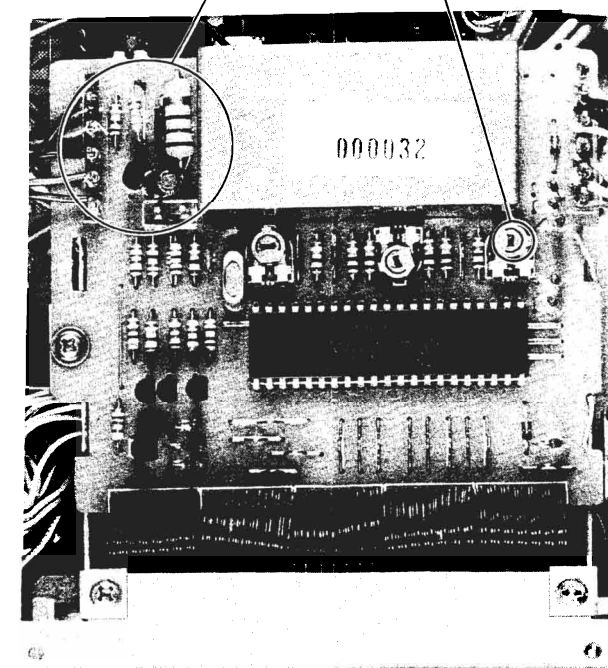
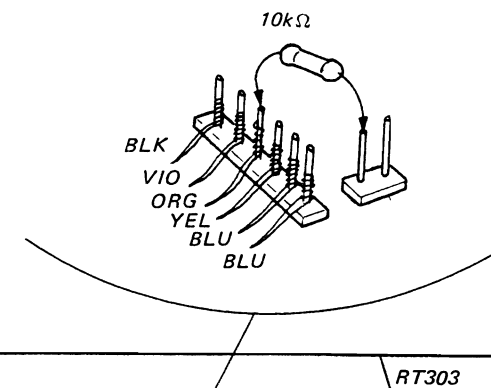

3-2. FM SECTION

FM DISCRIMINATOR ALIGNMENT 2

Setting: FUNCTION switch: TUNER
 Band Selector switch: FM
 MODE switch: MONO

carrier frequency: 98MHz
 Output level: 1mV (60dB)
 Modulation: 400Hz, 40kHz deviation (100%)

Procedure:
 Adjust the black core (secondary side) of IFT201 for minimum distortion.

FM IF ALIGNMENT

Setting: FUNCTION switch: TUNER
 Band Selector switch: FM
 MODE switch: MONO

Carrier frequency: 98MHz
 Output level: 12.5μV (22dB)
 Modulation: 400Hz, 40kHz deviation (100%)

Procedure:
 Adjust T5 for a maximum reading on VTVM.

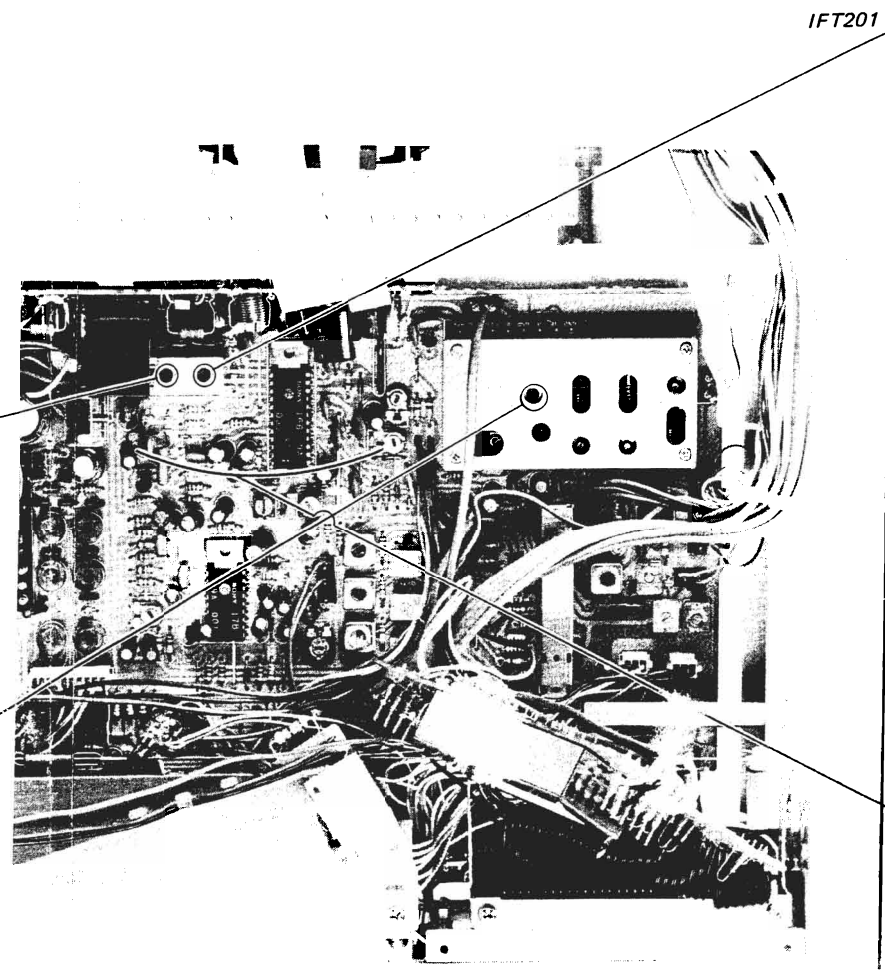

FM DISCRIMINATOR ALIGNMENT 1

Setting: FUNCTION switch: TUNER
 Band Selector switch: FM
 MODE switch: MONO
 TUNING: Detuned position

Procedure:
 Adjust the orange core (primary-side) of IFT201 for 0V reading on VOM.

Note: When replacing the ceramic filter (CF201), perform this alignment.

primary side: ORG
 secondary side: BLK

IC201
 R214
 R219

Setting: FUNCTION switch: TUNER
 Band Selector switch: FM
 MODE Selector: MONO

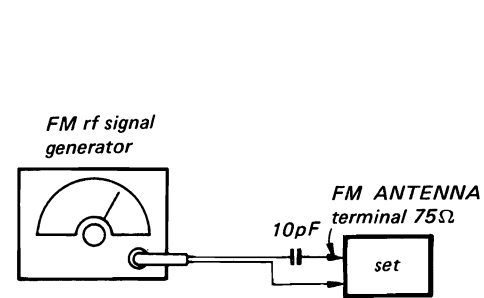

Modulation: 400Hz, 40kHz deviation (100%)

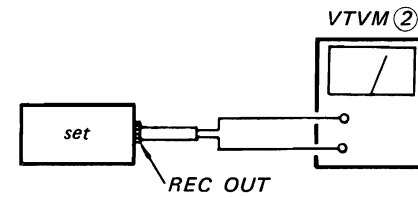

• Repeat the procedures in each adjustment several times, and the frequency coverage and tracking adjustments should be finally done by the trimmer capacitors.

FM TRACKING ADJUSTMENT	
Adjust for a maximum reading on VTVM ② .	
T3	88MHz
T2	
T1	
CT1	108MHz
CT2	
CT3	

FM FREQUENCY INDICATION ADJUSTMENT

Setting: FM Rf Signal Generator: 98.0 MHz

Procedure:

1. Set the Band Selector switch to the FM position and connect a lead wire as shown below.

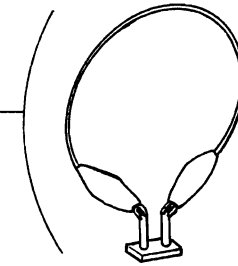

2. Tune the unit to the 98.0MHz signal precisely and adjust RT301 so that the rightmost digit on the display stops flickering.

FM FREQUENCY COVERAGE ADJUSTMENT			
Tuning Control Voltage Adjustment	Dial Indication	VTVM ① Reading	Adjustment Part
	maximum frequency	22.08V	RT801
	minimum frequency	2.73V	RT803
Adjust for a specified reading on VTVM ① .			
Local Oscillator Frequency Adjustment	Dial Indication	FM Rf Signal Generator Frequency	Adjustment Part
	minimum frequency	88MHz	T4
	maximum frequency	108MHz	CT4
Adjust for a maximum reading on VTVM ② .			
Dial Pointer Setting	Dial Indication	FM Rf Signal Generator Frequency	Adjustment Part
	98MHz	98MHz	RT802
Adjust for a maximum reading on VTVM ② .			

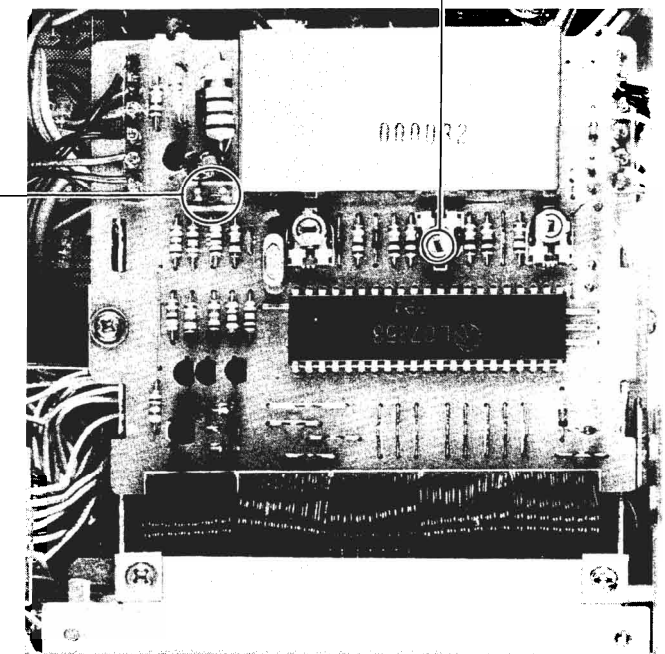
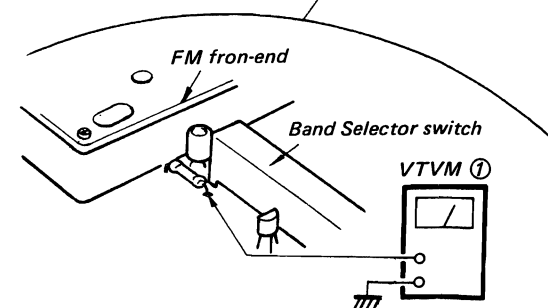
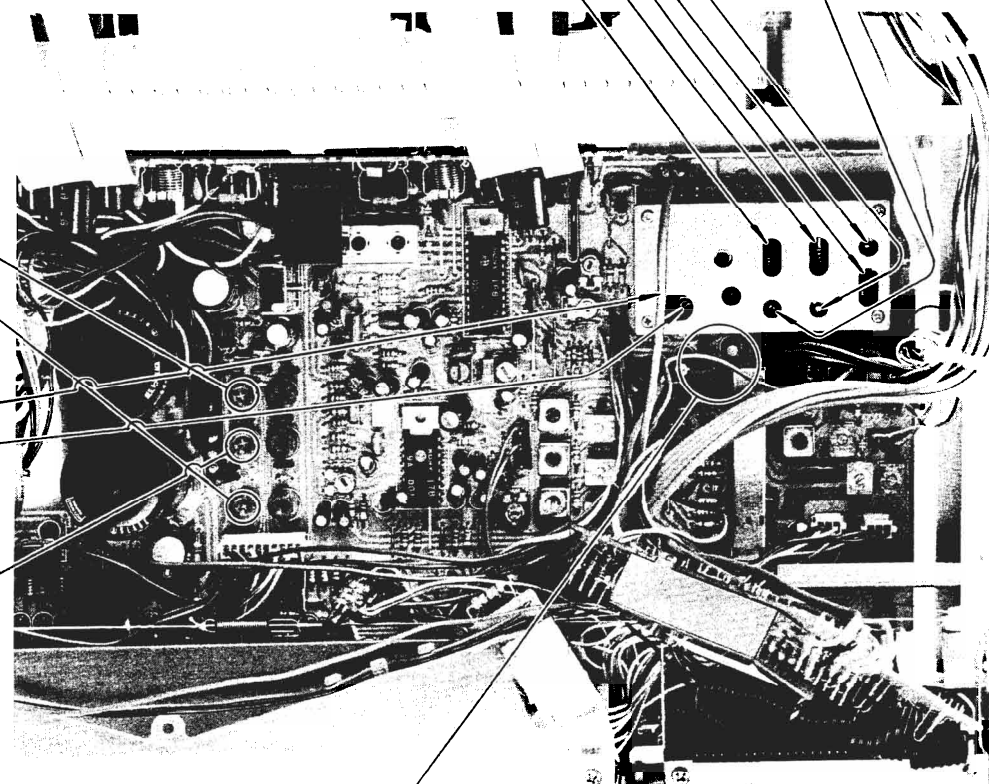

VCO ADJUSTMENT

Setting: FUNCTION switch: TUNER
 Band Selector switch: FM
 MODE switch: STEREO/FM-AM MUTING

A) Regular Method

FM stereo signal generator

Carrier frequency: 98MHz
 Output level: 1mV
 Modulation: no modulation

FM ANTENNA terminal 75Ω

Procedure:
 Adjust RT204 for 76kHz ±100Hz on the frequency counter.

frequency counter

B) Simple Method

Procedure:

1. Turn the set to the FM stereo broadcasting signal.
2. Turn RT204 clockwise or counterclockwise and memorize the lighting-up range of STEREO lamp.
3. Secure at the center in lighting-up range of both turns as shown below.

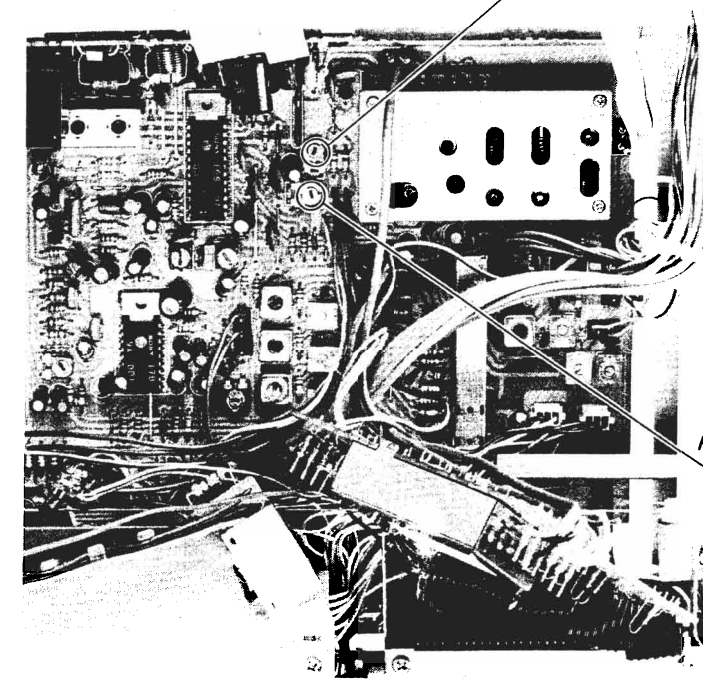
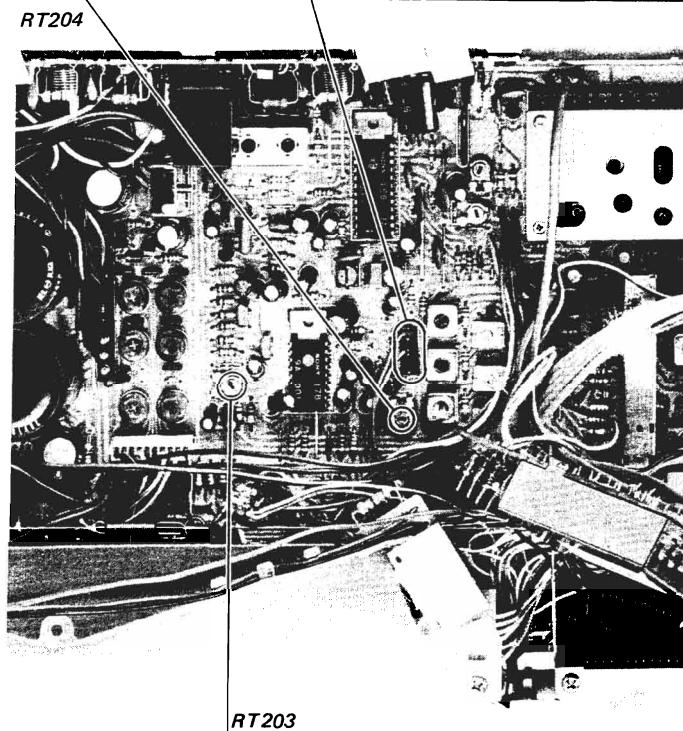

MUTING LEVEL ADJUSTMENT

Setting: FUNCTION switch: TUNER
 Band Selector switch: FM
 MODE switch: STEREO/FM-AM MUTING

Procedure:

FM rf signal generator

Carrier frequency: 98MHz
 Modulation: 400Hz, 40kHz deviation (100%)
 Output level: 16μV (22dB)

Turn RT201 and stop it just when the VOM indication suddenly decreases.

SIGNAL METER CALIBRATION

Setting: FUNCTION switch: TUNER
 Band Selector switch: FM

FM rf signal generator

Carrier frequency: 98MHz
 Modulation: 400Hz, 40kHz deviation (100%)

Procedure:
 Adjust RT202 for the specified meter indication.

Generator Output Level	Meter Indication
100μV (40dB)	Light. SIGNAL
1000μV (60dB)	Light. SIGNAL

FM STEREO SEPARATION ADJUSTMENT

Setting: FUNCTION switch: TUNER
 Band Selector switch: FM
 MODE switch: STEREO/FM-AM MUTING

FM stereo signal generator

Carrier frequency: 98MHz
 Output level: 1mV (60dB)
 Modulation:
 Audio (400Hz): 20kHz deviation (50%)
 Pilot (19kHz): 6.3kHz deviation (16%)
 Sub channel (38kHz): 20kHz deviation (50%)

FM ANTENNA 75Ω REC OUT

Procedure:

FM stereo signal generator output channel	VTVM connection	VTVM reading (dB)
L-CH	L-CH	(A)
R-CH	L-CH	(B)
R-CH	R-CH	(C)
L-CH	R-CH	(D)

Adjust RT203 resistor for minimum reading.

L-CH Stereo separation: (A) - (B)
 R-CH Stereo separation: (C) - (D)

The separations of both channels should be equal.

The difference between separations (A)-(B) and (C)-(D) are to be equal.

POWER LEVEL METER BRIGHTNESS ADJUSTMENT

Procedure:

Adjust RT701 for the same brightness of L-CH and R-CH power level meters.

Adjustment Location: meter board

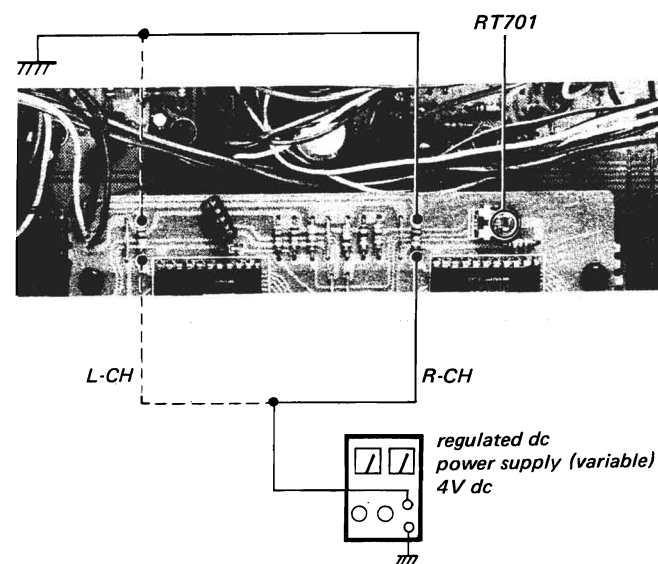

POWER LEVEL METER CALIBRATION

Setting: FUNCTION switch: TAPE 1
MODE switch: STEREO/FM-AM
MUTING

Procedure:

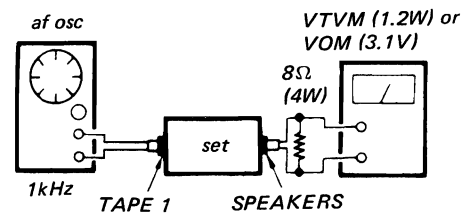

1. Adjust the VOL and the BAL controls for a 1.2W VTVM reading or a 3.1V VOM reading. (for both channels)
2. Adjust RT601 (L-CH) and RT651 (R-CH) so that the power level meter indicates 1.2W.

Adjustment Location: power amp board

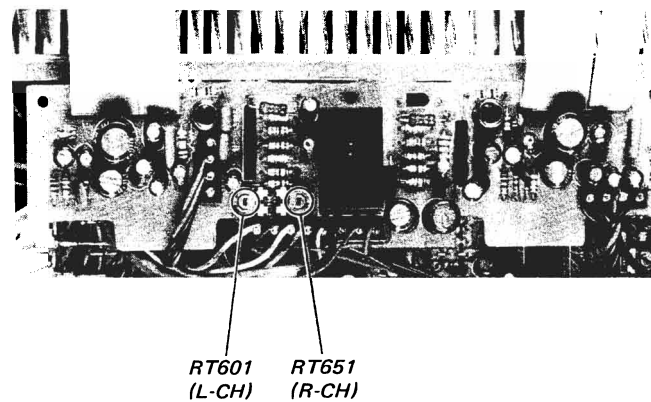

Replacement Semiconductors

For replacement, use semiconductors except in ().

Q201-203, 213, 301 : 2SC1364 (2SC1815)
Q307, 308, 802 : 2SC1364 (2SC1815)
Q204 : 2SC1345

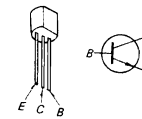

IC301: LC7253

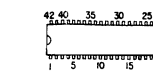

(Top view)

IC302: MSL2318RS

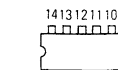

(Top view)

IC401, 451 : HA1457
IC501, 551

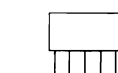

(Marking side view)

IC601, 651: SI1340H

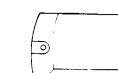

(Marking side view)

IC602: HA12002

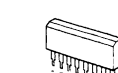

IC603: TA7318P

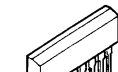

IC701, 751: IR2406G

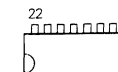

(Top view)

IC201: CX168

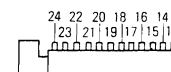

(Top view)

IC202: CX178

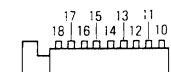

(Top view)

D201, 202: ISV118

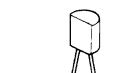

(Top view)

D203-215, 301-313 : 1S1555
D813-815, 907, 908

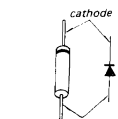

D314, 808 : EQB01-05 (EQA01-05R)
D315 : EQB01-09 (EQA01-09R)
D807 : EQB01-16 (EQA01-16R)
D809, 810 : EQB01-22 (EQA01-22R)

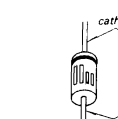

D601, 602, 806: 10E2 (RA1Z)

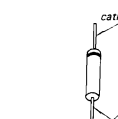

D801-804: U05G (S2V20)

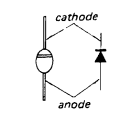

D805: SIVB20 (SIVB10)

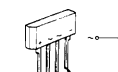

D901: GL9PR21
D902: GL9NG21

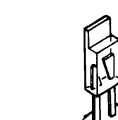

D903-906: GL2HY1

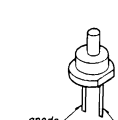

4-1. MOUNTING DIAGRAM
- Conductor Side -

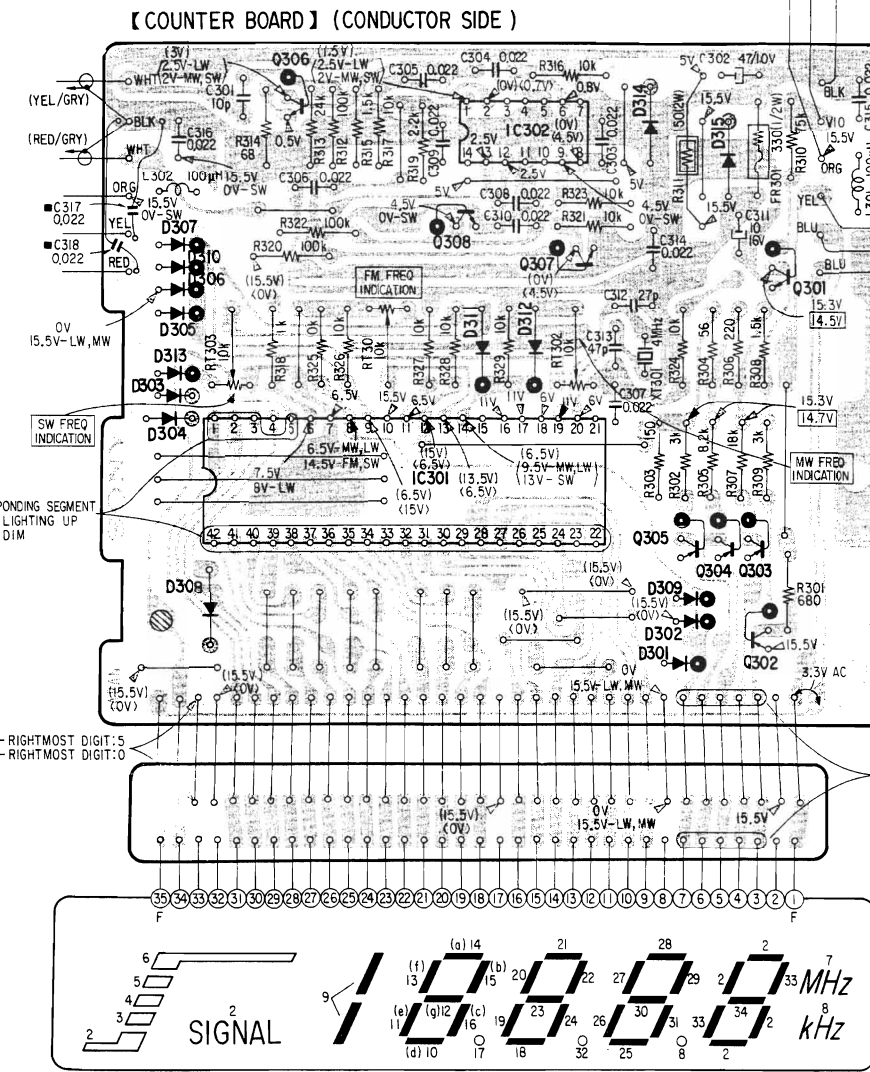
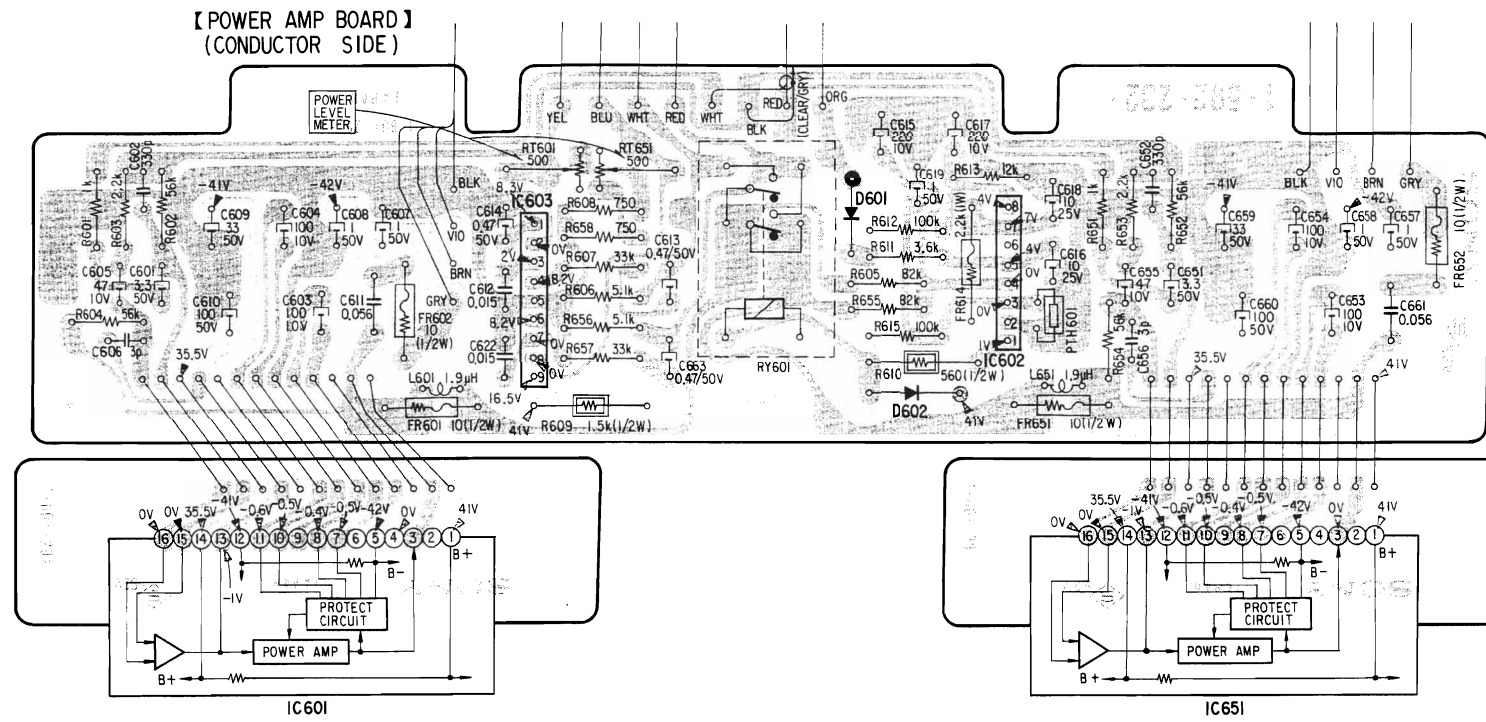

Q, IC	D
306	314
IC302	315
308	307
307	310
301	306
	305
	311,312
	313
	303
	304
IC301	
303-305	
302	309
	302
	301

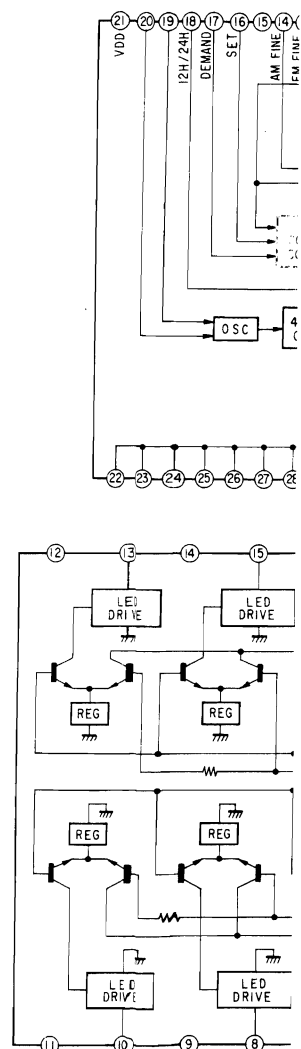

Note:
● Color code of sleeving over the end of the jacket.

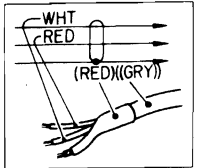

- — : parts extracted from the component side.
- — : parts extracted from the conductor side.
- — : part mounted on the conductor side.
- ■ : B+ pattern.

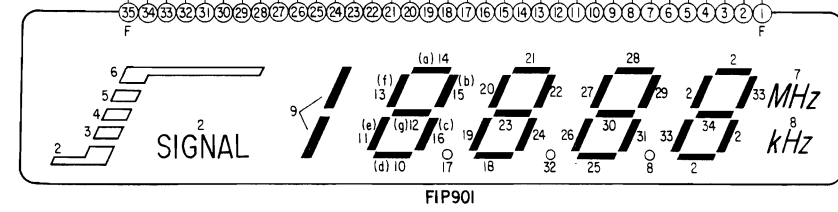

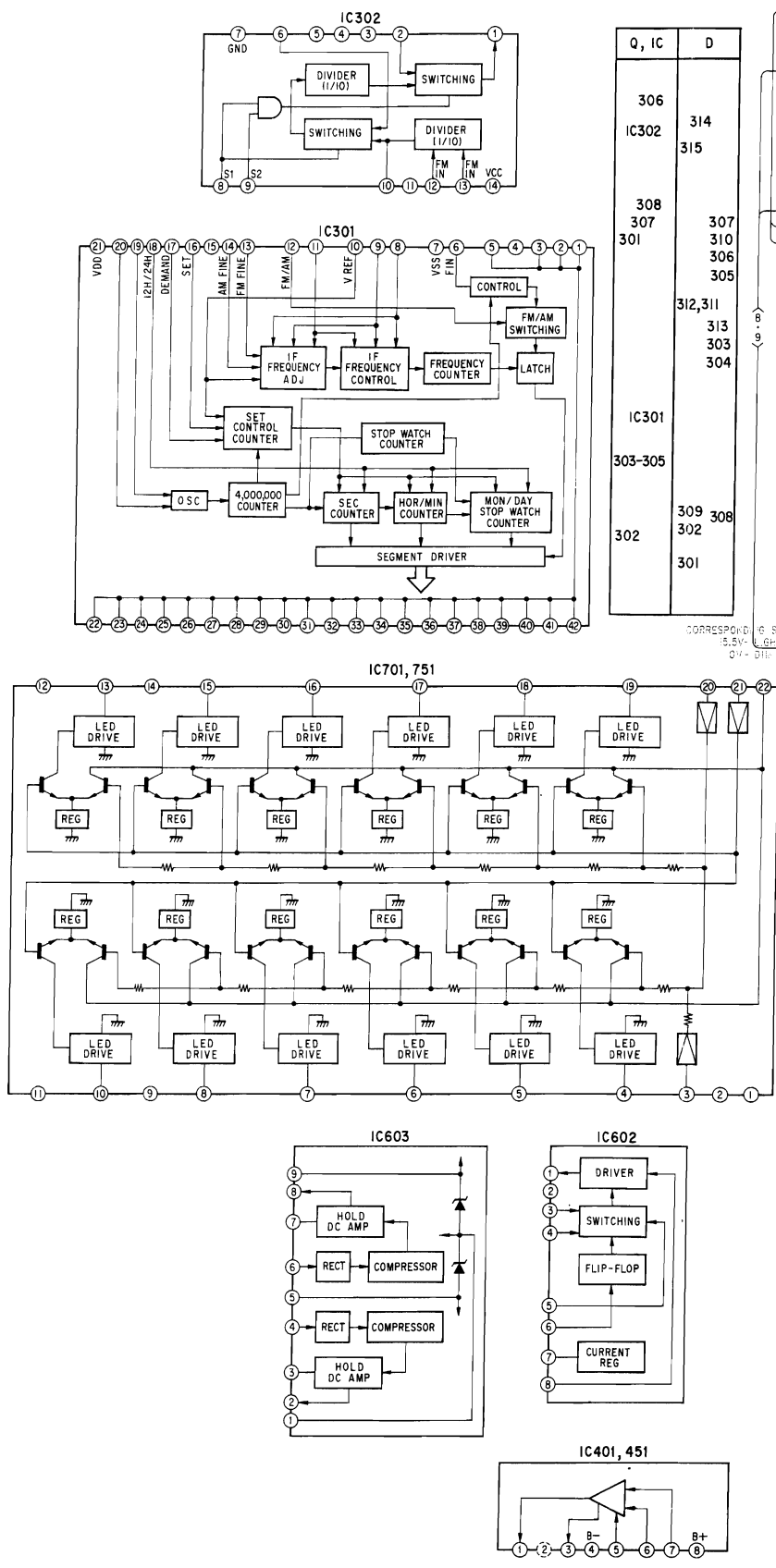

Q, IC	D
306	314
IC302	315
308	307
307	310
301	306
	305
	312, 311
	313
IC301	303
	304
303-305	
	309
	302
302	308
	301

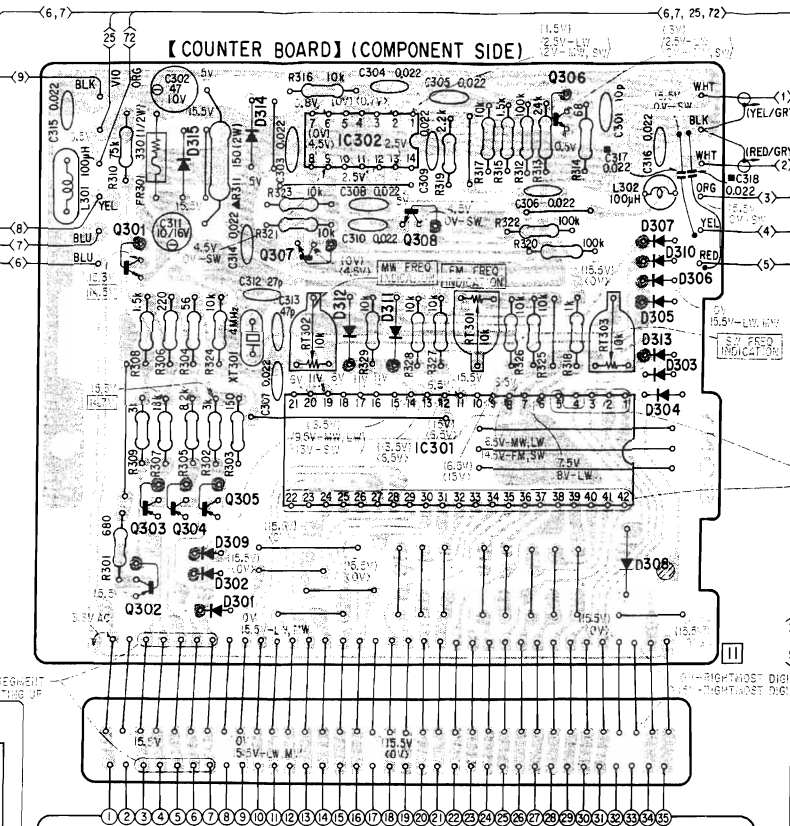

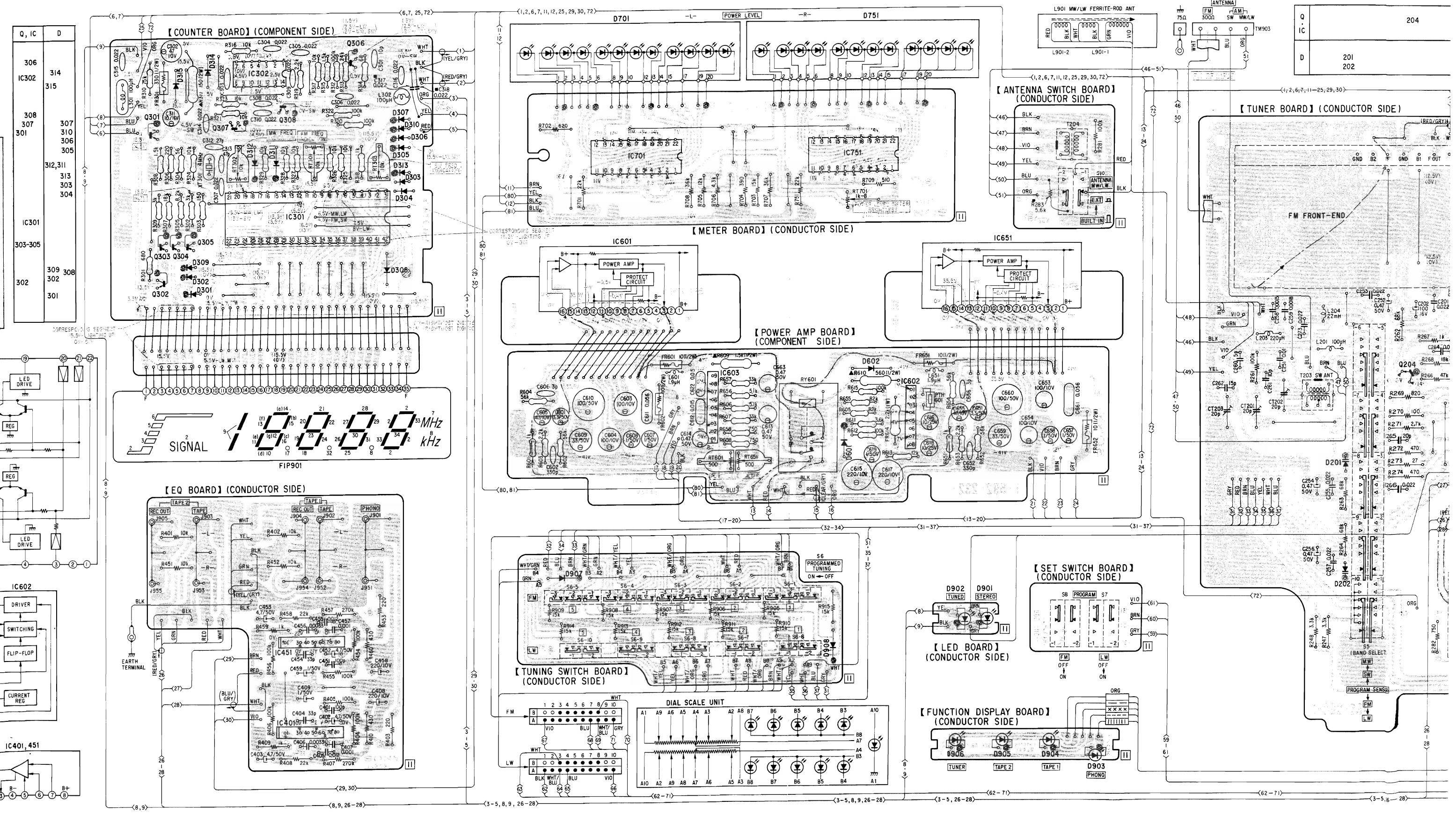

Q	IC	204
D		201 202

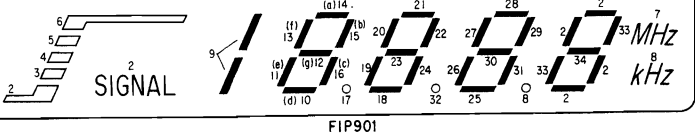

STR-434L STR-434L

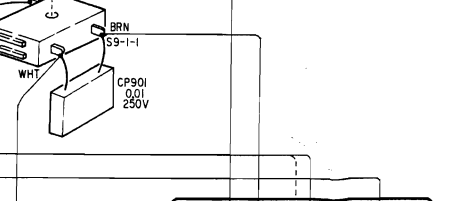
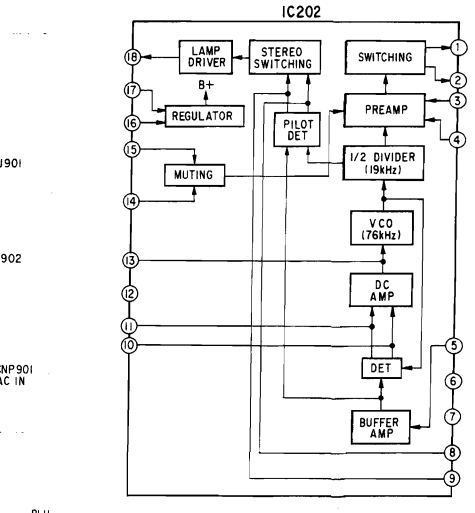
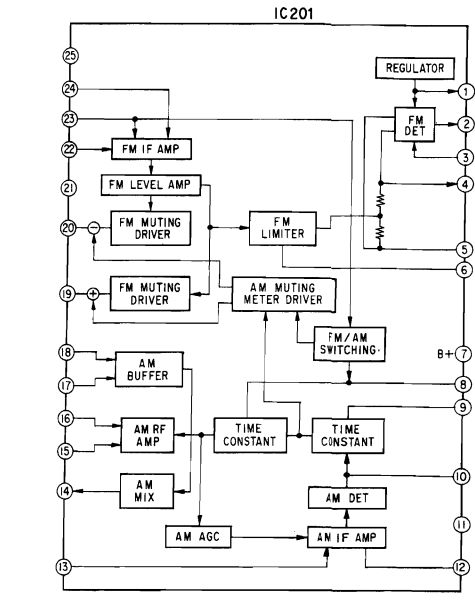
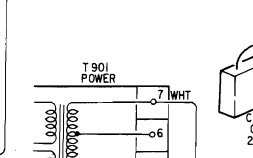
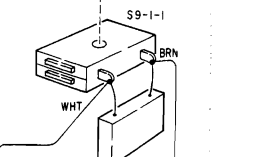
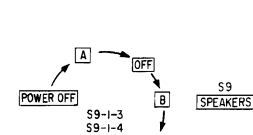
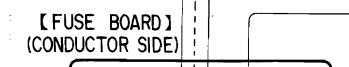
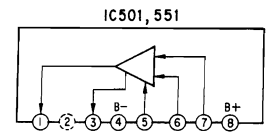
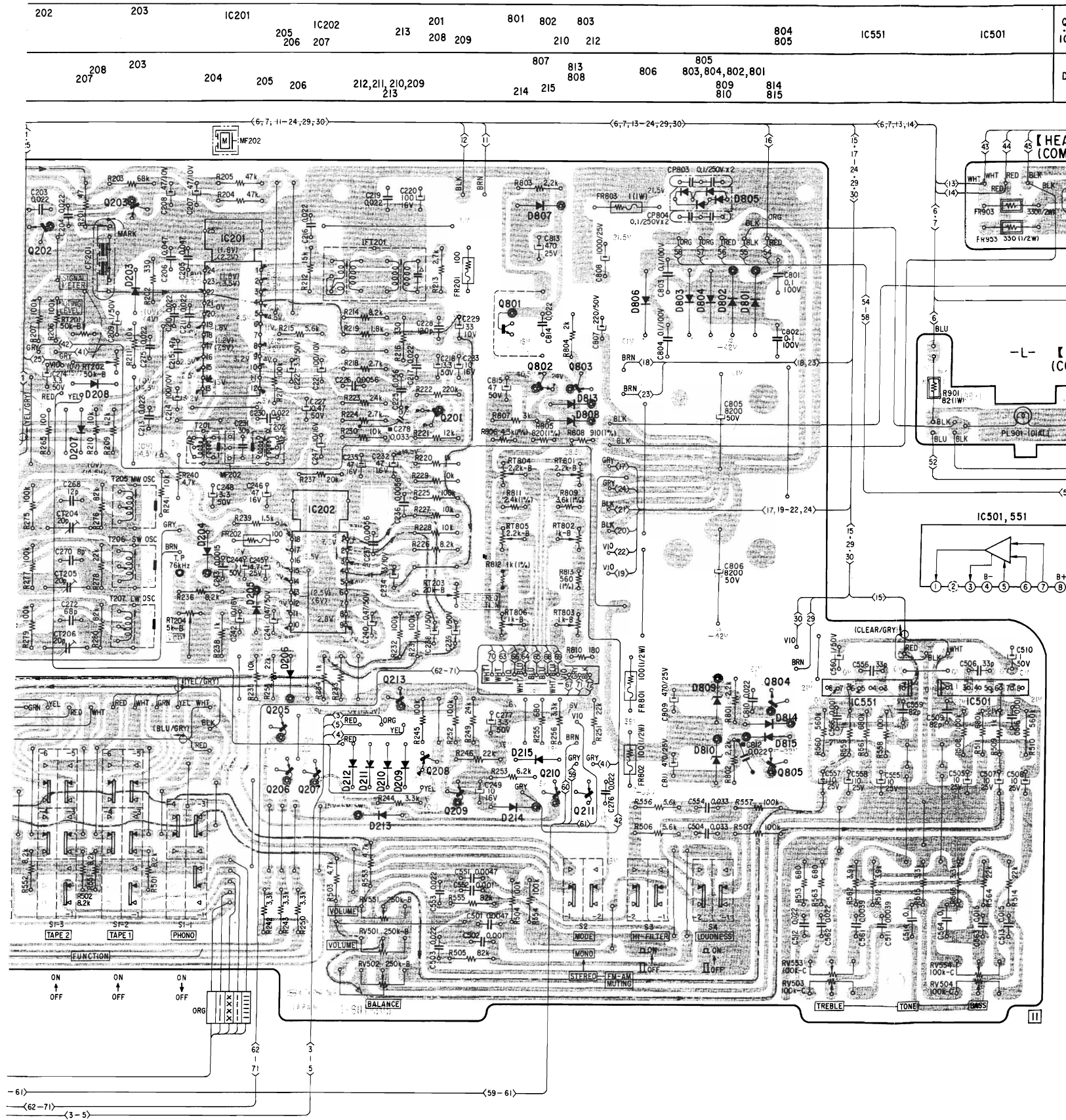

STR-434L STR-434L

4-3. SCHEMATIC DIAGRAM

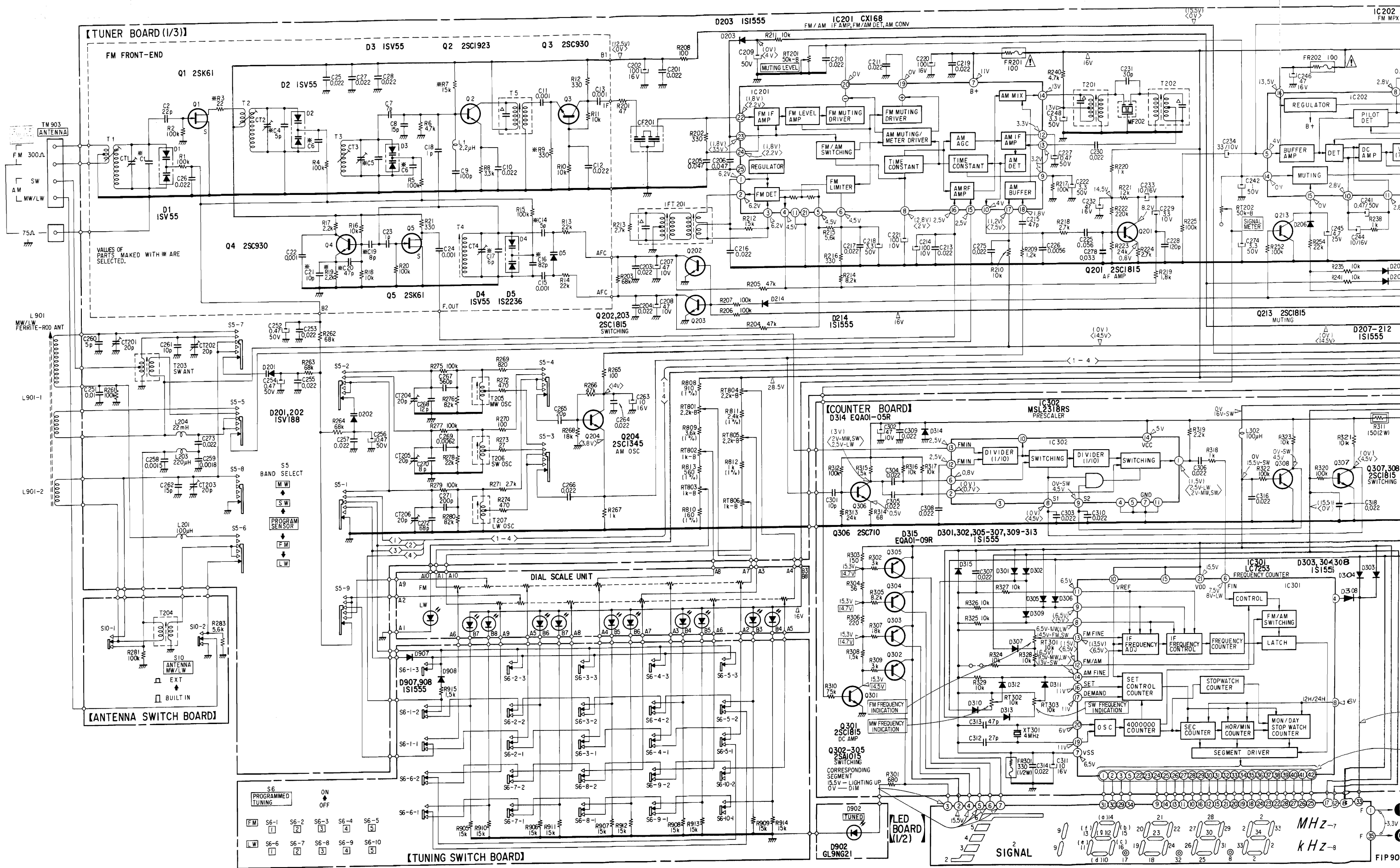

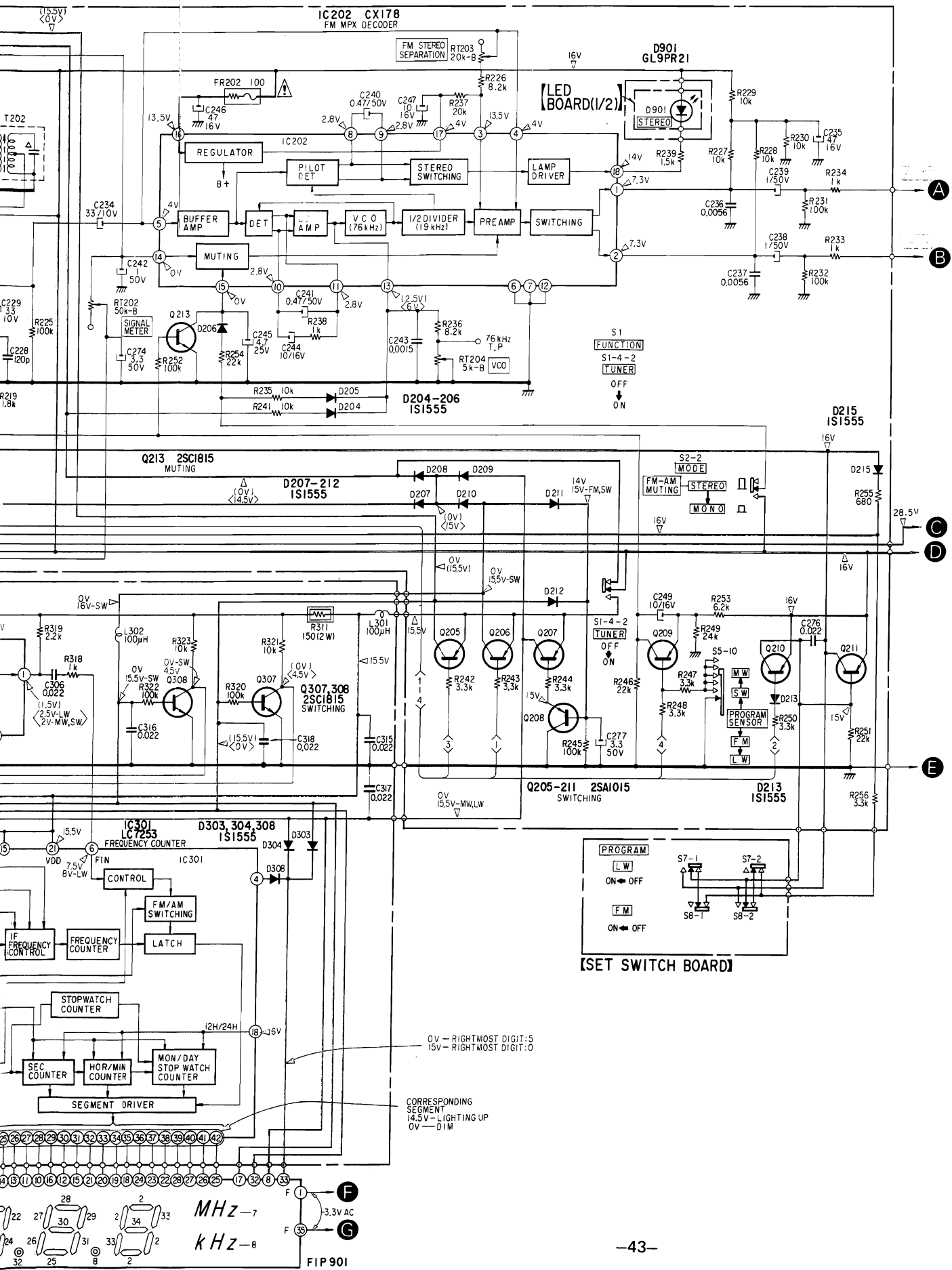

(FOR MOUNTING DIAGRAM)

Note:
 • Color code of sleeving over the end of the jacket.

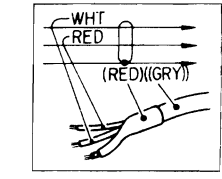

- : parts extracted from the component side.
- : parts extracted from the conductor side.
- : indicates side identified with part number.
- : part mounted on the conductor side.

- ▲ : nonflammable resistor.
- : B+ pattern
- : Signal Path
- : R-CH signal path
- : L-CH signal path

Note: The components identified by shading and mark are critical for safety. Replace only with part number specified.

(FOR SCHEMATIC DIAGRAM)

- Note:
- All capacitors are in μF unless otherwise noted. $pF : \mu\mu F$
 - 50WV or less are not indicated except for electrolytics and tantalum.
 - All resistors are in ohms, $\frac{1}{4}W$ unless otherwise noted. $k\Omega : 1000\Omega, M\Omega : 1000k\Omega$
 - [Resistor symbol with diagonal line] : nonflammable resistor.
 - [Resistor symbol with diagonal line and wavy line] : fusible resistor.
 - [Triangle symbol] : internal component.
 - [Square symbol] : panel designation.
 - [Square symbol with diagonal line] : adjustment for repair.
 - ○ : B+ bus.
 - ○ : B- bus.
 - Voltages are dc with respect to ground unless otherwise noted.
 - Readings are taken under detuned conditions with a VOM (20k Ω/V).
 - [Square symbol with 'FM'] : FM
 - [Square symbol with 'SET IS TUNED'] : SET IS TUNED.
 - [Square symbol with '< >'] : AM
 - Voltage variations may be noted due to normal production tolerances.
 - Switch

Ref. No.	Switch	Position
S1	FUNCTION	
S1-1	PHONO	ON
S1-2	TAPE 1	OFF
S1-3	TAPE 2	OFF
S1-4	TUNER	OFF
S2	MODE	STEREO, FM -AM MUTING
S3	HI FILTER	OFF
S4	LOUDNESS	OFF
S5	Band Select	PROGRAM SENSOR
S6	PROGRAMMED TUNING	FM [1]
S7	PROGRAM (LW)	OFF
S8	PROGRAM (FM)	OFF
S9	SPEAKERS (POWER)	POWER OFF
S10	ANTENNA	BUILT IN

STR-434L STR-434L

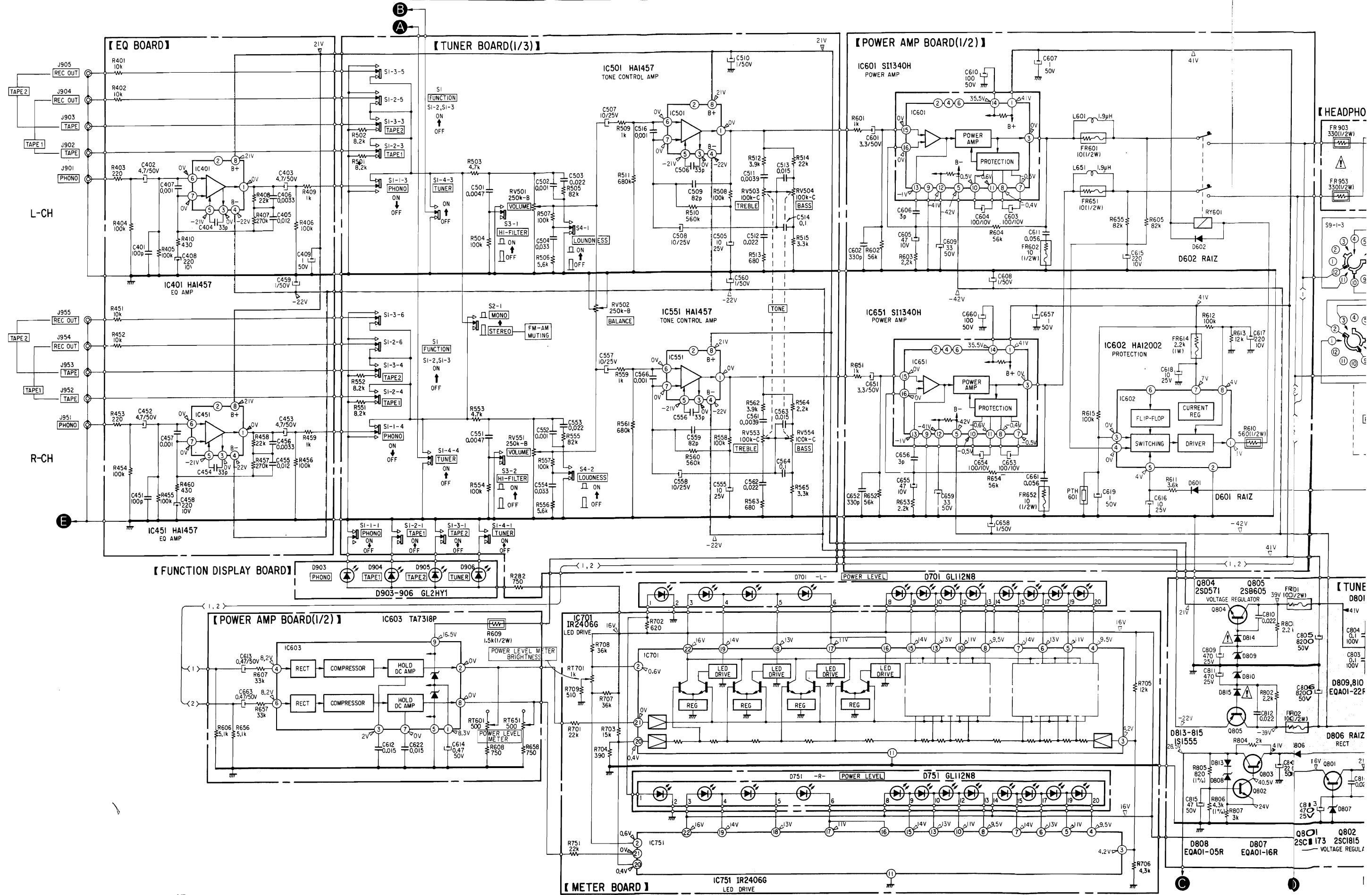

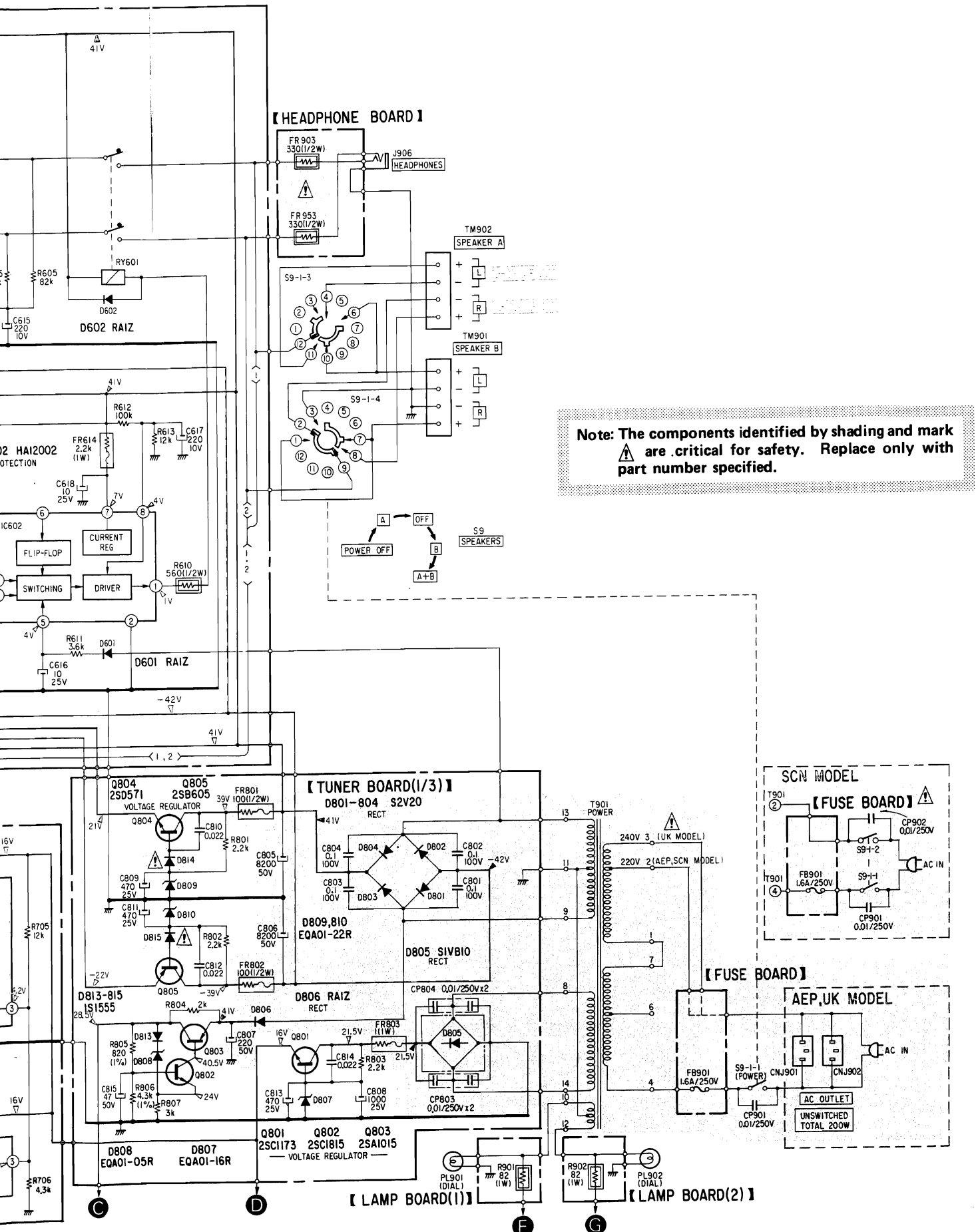

Note: The components identified by shading and mark are critical for safety. Replace only with part number specified.

Note:

- All capacitors are in μF unless otherwise noted. $\text{pF} : \mu\mu\text{F}$ 50WV or less are not indicated except for electrolytics and tantalum.
- All resistors are in ohms, $\frac{1}{4}\text{W}$ unless otherwise noted. $\text{k}\Omega : 1000\Omega$, $\text{M}\Omega : 1000\text{k}\Omega$
- : nonflammable resistor.
- : fusible resistor.
- : internal component.
- : panel designation.
- : adjustment for repair.
- : B+ bus.
- : B- bus.
- Voltages are dc with respect to ground unless otherwise noted.
- Readings are taken under detuned conditions with a VOM ($20\text{k}\Omega/\text{V}$).
 () : FM
 □ : SET IS TUNED.
 < > : AM
- Voltage variations may be noted due to normal production tolerances.
- Switch

Ref. No.	Switch	Position
S1	FUNCTION	
S1-1	PHONO	ON
S1-2	TAPE 1	OFF
S1-3	TAPE 2	OFF
S1-4	TUNER	OFF
S2	MODE	STEREO, FM -AM MUTING
S3	HI FILTER	OFF
S4	LOUDNESS	OFF
S5	Band Select	PROGRAM SENSOR
S6	PROGRAMMED TUNING	FM 1
S7	PROGRAM (LW)	OFF
S8	PROGRAM (FM)	OFF
S9	SPEAKERS (POWER)	POWER OFF
S10	ANTENNA	BUILT IN

SECTION 5 EXPLODED VIEWS

STR-434L

A

B

C

D

(1)

Note:

- Items with no part number and/or no description are not stocked because they are seldom required for routine service.
- All screws are Phillips (cross recess) type unless otherwise noted.
(-) = slotted head
- Circled letters (A) to (Z) are applicable to European models only.

X-4864-406-2 (N)
Front Panel Ass'y; including parts marked ▲ 1, 2

4-864-457-00 (I)
Case

4-864-419-12 (B)
Adiabatic Sheet

X-4864-302-0 (A)
Foot Stopper Ass'y

4-847-802-11 (A)
Screw, case

4-861-045-00
Label, caution

4-847-802-11 (A)
Screw, case

Label, MADE IN JAPAN
(UK model)

PTT3x6

3-831-441-XX (B)
Felt

▲ 1
4-864-330-00 (B)
Holder (L), panel

BVTT
3x6

BVTT
3x6

Bottom Plate

X-4864-401-1 (C)
Knob Ass'y; SPEAKERS,
TONE

X-4864-403-0 (D) Knob Ass'y, BAL
X-4864-404-0 (D) Knob Ass'y, VOL

X-4864-401-2 (C)
Knob Ass'y, BAND SELECT

X-4864-402-0 (D)
Knob Ass'y, TUNING

Printed Circuit Board,
function display

4-864-435-00 (B)
Spring

4-864-422-00 (B)
Knob, PROGRAMMED
TUNING

Holder

4-864-331-00 (B)
Holder (R), panel

Heat Sink

BVTT3x6

X-4864-303-0 (A)
Foot Ass'y

1-226-231-00 (D)
Resistor, variable 100k Ω /100k Ω -C; BASS,
TREBLE (RV503, 504, RV553, 554)

4-864-307-00 (A)
Ring, flexible

Bracket, switch

Supplied with variable resistor

4-864-328-00 (B)
Knob; FUNCTION, LOUDNESS,
HI-FILTER, MODE

Supplied with variable resistor

BVTT3x6

Supplied with switch

1-226-339-00 (G)
Resistor, variable 250k/250k/250k Ω ;
VOL, BAL (RV501, 502, 551)

1-553-062-00 (D)
Switch, pushbutton; MODE/
HI-FILTER/LOUDNESS (S2, 3, 4)

3-701-589-00 (A)
P3x8

1-463-289-00 (M)
Front End

Complete Circuit Board, tuner

1-553-066-00 (F)
Switch, rotary-slide; BAND SELECT (S5)

1-553-063-00 (G)
Switch, pushbutton; FUNCTION (S1)

1

2

3

4

5

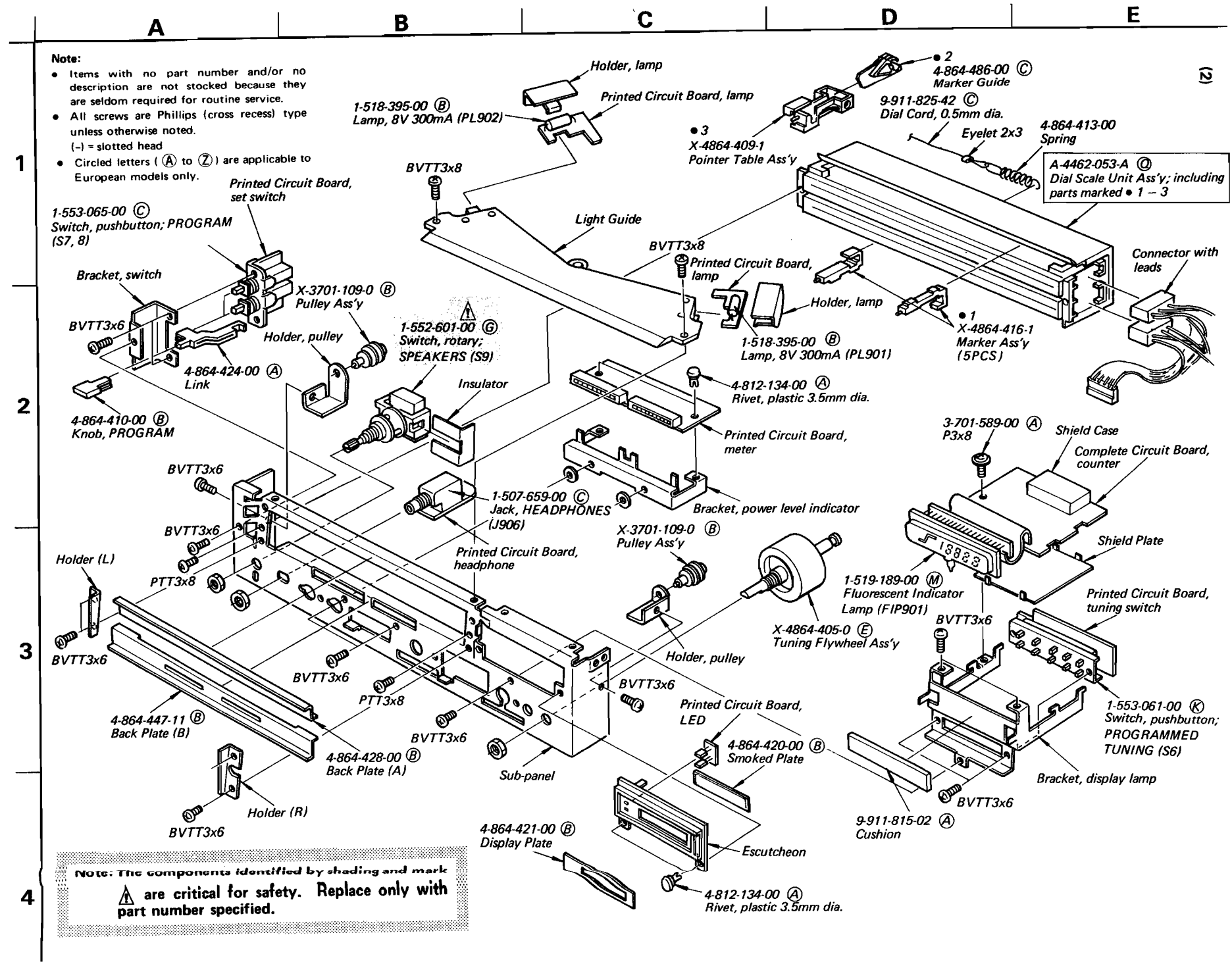

Note:

- Items with no part number and/or no description are not stocked because they are seldom required for routine service.
- All screws are Phillips (cross recess) type unless otherwise noted.
- (-) = slotted head
- Circled letters (A) to (Z) are applicable to European models only.

1-553-065-00 (C)
Switch, pushbutton; PROGRAM (S7, B)

X-3701-109-0 (B)
Pulley Ass'y

4-864-424-00 (A)
Link

4-864-410-00 (B)
Knob, PROGRAM

BVTT3x6

BVTT3x6

PTT3x8

4-864-447-11 (B)
Back Plate (B)

4-864-428-00 (B)
Back Plate (A)

BVTT3x6

Holder (R)

Note: The components identified by shading and mark are critical for safety. Replace only with part number specified.

1-518-395-00 (B)
Lamp, 8V 300mA (PL902)

BVTT3x8

1-552-601-00 (C)
Switch, rotary; SPEAKERS (S9)

1-507-659-00 (C)
Jack, HEADPHONES (J906)

Printed Circuit Board, headphone

Printed Circuit Board, lamp

PTT3x8

BVTT3x6

BVTT3x6

BVTT3x6

Sub-panel

4-864-421-00 (B)
Display Plate

Holder, lamp

Printed Circuit Board, lamp

Light Guide

Insulator

1-507-659-00 (C)
Jack, HEADPHONES (J906)

Printed Circuit Board, headphone

PTT3x8

BVTT3x6

BVTT3x6

BVTT3x6

Sub-panel

4-864-421-00 (B)
Display Plate

•3
X-4864-409-1
Pointer Table Ass'y

BVTT3x8
Printed Circuit Board, lamp

1-518-395-00 (B)
Lamp, 8V 300mA (PL901)

4-812-134-00 (A)
Rivet, plastic 3.5mm dia.

Printed Circuit Board, meter

Bracket, power level indicator

X-3701-109-0 (B)
Pulley Ass'y

Holder, pulley

Printed Circuit Board, LED

4-864-420-00 (B)
Smoked Plate

Escutcheon

4-812-134-00 (A)
Rivet, plastic 3.5mm dia.

•2
4-864-486-00 (C)
Marker Guide

9-911-825-42 (C)
Dial Cord, 0.5mm dia.

Eyelet 2x3

4-864-413-00
Spring

A-4462-053-A (C)
Dial Scale Unit Ass'y; including parts marked • 1 - 3

Holder, lamp

•1
X-4864-416-1
Marker Ass'y (5PCS)

Printed Circuit Board, meter

3-701-589-00 (A)
P3x8

Shield Case

Complete Circuit Board, counter

Shield Plate

Printed Circuit Board, tuning switch

BVTT3x6

1-519-189-00 (M)
Fluorescent Indicator Lamp (FIP901)

X-4864-405-0 (E)
Tuning Flywheel Ass'y

BVTT3x6

1-553-061-00 (K)
Switch, pushbutton; PROGRAMMED TUNING (S6)

Bracket, display lamp

BVTT3x6

9-911-815-02 (A)
Cushion

(2)

Note: Circled letters (A) to (Z) are applicable to European models only.

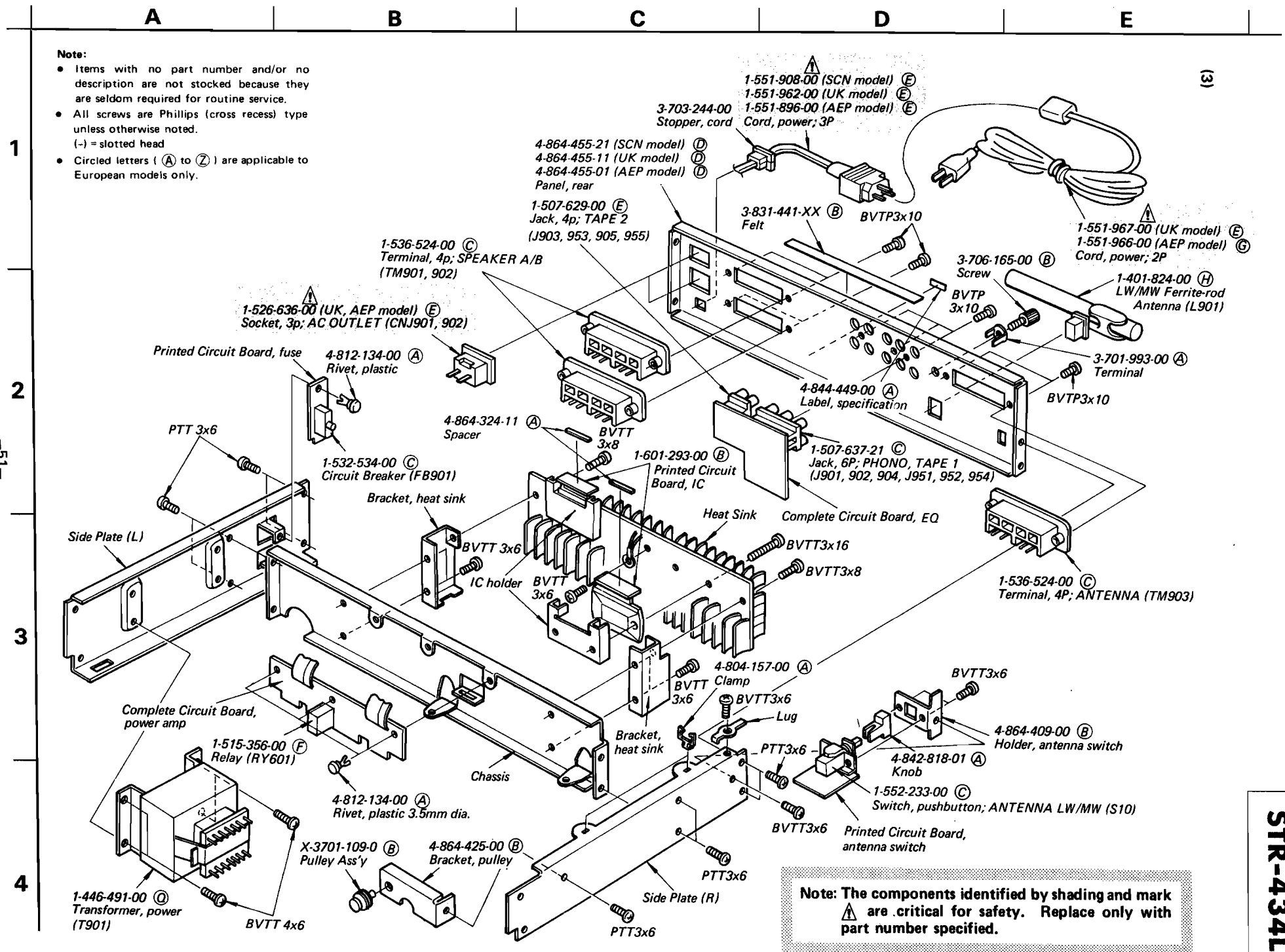

Note:

- Items with no part number and/or no description are not stocked because they are seldom required for routine service.
- All screws are Phillips (cross recess) type unless otherwise noted.
- (-) = slotted head
- Circled letters (A) to (Z) are applicable to European models only.

Note: The components identified by shading and mark Δ are critical for safety. Replace only with part number specified.

⇒ Due to standardization, interchangeable replacements may be substituted for parts specified in the diagrams.

Ref. No.	Part No.	Description
SEMICONDUCTORS		
Transistors		
⇒ Q201-203	8-729-663-47	(B) 2SC1364
⇒ Q204	8-729-334-58	(B) 2SC1345
⇒ Q205-211	8-729-201-52	(B) 2SA1015
⇒ Q213	8-729-663-47	(B) 2SC1364
⇒ Q301	8-729-663-47	(B) 2SC1364
⇒ Q302-305	8-729-201-52	(B) 2SA1015
⇒ Q306	8-729-671-15	(B) 2SC710-15
⇒ Q307, 308	8-729-663-47	(B) 2SC1364
⇒ Q801	8-729-217-33	(C) 2SC1173
⇒ Q802	8-729-663-47	(B) 2SC1364
⇒ Q803	8-729-201-52	(B) 2SA1015
⇒ Q804	8-760-413-10	(B) 2SC1475
⇒ Q805	8-729-160-51	(B) 2SB605
ICs		
IC201	8-751-680-01	(J) CX168
IC202	8-751-780-00	(H) CX178
IC301	8-759-872-53	(M) LC7253
IC302	8-759-923-18	(J) MSL2318RS
IC401, 451	8-759-314-57	(C) HA1457
IC501, 551	8-759-314-57	(C) HA1457
IC601, 651	8-759-313-40	(M) S11340H
IC602	8-759-320-02	(E) HA12002
IC603	8-759-273-18	(D) TA7318P
IC701, 751	8-759-924-07	(H) IR2406G
Diodes		
D201, 202	8-719-100-81	(D) 1SV118
D203-215	8-719-815-55	(B) 1S1555
D301-313	8-719-815-55	(B) 1S1555
⇒ D314	8-719-931-05	(B) EQB01-05
⇒ D315	8-719-931-09	(B) EQB01-09
TRANSFORMERS		
T201	1-409-323-00	(B) Filter
T202	1-409-324-00	(B) Filter
T203	1-401-822-00	(B) SW ANT
T204	1-401-819-00	(B) Antenna
T205	1-405-881-00	(B) MW Osc
T206	1-405-885-00	(B) SW Osc
T207	1-405-882-00	(B) LW Osc
T901	Δ 1-446-491-00	(C) Transformer, power
IFT201	1-404-167-00	(D) FM Discriminator
COILS		
L204	1-407-210-XX	(B) 22mH, microinductor
L301	1-407-750-00	(B) 100 μ H, microinductor
L302	1-407-169-XX	(B) 100 μ H, microinductor
L901	1-401-824-00	(H) LW/MW Ferrite-rod Antenna
⇒ D809, 810	8-719-931-22	(B) EQB01-22
D813	8-719-815-55	(B) 1S1555
D814, 815	Δ 8-719-815-55	(B) 1S1555
D901	8-719-909-21	(B) GL9PR21
D902	8-719-909-22	(B) GL9NG21
D903-906	8-719-900-21	(B) GL2HY1
D907, 908	8-719-815-55	(B) 1S1555
⇒ D601, 602	8-719-200-02	(E) 10E2
D701, 751	8-719-911-28	(H) GL112N8
⇒ D801-804	Δ 8-719-911-55	(C) U05G
⇒ D805	Δ 8-719-511-20	(C) S1VB20
⇒ D806	Δ 8-719-200-02	(E) 10E2
⇒ D807	8-719-931-16	(B) EQB01-16
⇒ D808	8-719-931-05	(B) EQB01-05

Note: The components identified by shading and mark Δ are critical for safety. Replace only with part number specified.

Note: Circled letters (A to Z) are applicable to European models only.

Note: Circled letters (A to Z) are applicable to European models only.

Ref. No. Part No. Description

CAPACITORS

All capacitors are in μ F and ceramic unless otherwise noted. 50WV or less are not indicated except for electrolytics. Common capacitors are omitted. Refer to the lists on pages 55 and 56 for their part numbers.

C243	1-104-081-00	(B) 0.0015	polystyrol
C267	1-103-719-00	(B) 560p	polystyrol
C269	1-103-744-00	(B) 0.0062	polystyrol
C271	1-103-708-00	(B) 200p	polystyrol
C801-804	(A)1-108-389-00	(B) 0.1 100V	mylar
C805, 806	(A)1-125-204-00	(B) 8200 50V	elect
C807	(A)1-123-361-00	(B) 220 50V	elect
CT201-206	1-141-171-XX	(B) Trimmer	

RESISTORS

All resistors are in ohms. Common $\frac{1}{4}$ W carbon resistors are omitted. Refer to the list on page 55 for their part numbers.

R311	1-206-644-00	(B) 150	2W	metal oxide (nonflammable)
R609	1-247-244-00	(A) 1.5k	$\frac{1}{2}$ W	(nonflammable)
R610	1-247-234-00	(A) 560	$\frac{1}{2}$ W	(nonflammable)
R805	1-214-130-00	(A) 820	$\frac{1}{4}$ W	metal oxide
R806	1-214-147-00	(A) 4.3k	$\frac{1}{4}$ W	metal oxide
R808	1-214-131-00	(A) 910	$\frac{1}{4}$ W	metal oxide
R809	1-214-145-00	(A) 3.6k	$\frac{1}{4}$ W	metal oxide
R810	1-214-113-00	(A) 160	$\frac{1}{4}$ W	metal oxide
R811	1-214-141-00	(A) 2.4k	$\frac{1}{4}$ W	metal oxide
R812	1-214-132-00	(A) 1k	$\frac{1}{4}$ W	metal oxide
R813	1-214-126-00	(A) 560	$\frac{1}{4}$ W	metal oxide
R901, 902	1-213-130-00	(A) 82	1W	metal oxide (nonflammable)
R905-914	1-246-797-00	(A) 15k	1/8W	carbon
RT201,202	1-226-238-00	(B) 50k, adjustable; MUTING LEVEL/SIGNAL METER CALIBRATION		
RT203	1-226-237-00	(B) 20k, adjustable; FM STEREO SEPARATION		

Note: The components identified by shading and mark **(A)** are critical for safety. Replace only with part number specified.

Ref. No. Part No. Description

RT204	1-226-235-00	(B) 5k, adjustable; VCO
RT301-303	1-226-236-00	(B) 10k, adjustable; FM/MW/SW FREQUENCY INDICATION
RT601, 651	1-226-232-00	(B) 500, adjustable; POWER LEVEL METER CALIBRATION
RT701	1-226-233-00	(B) 1k, adjustable; POWER LEVEL METER BRIGHTNESS
RT801	1-224-250-XX	(B) 2.2k, adjustable
RT802, 803	1-224-249-XX	(B) 1k, adjustable
RT804, 805	1-224-250-XX	(B) 2.2k, adjustable
RT806	1-224-249-XX	(B) 1k, adjustable
RV501,502	1-226-339-00	(G) 250k/250k/250k-B, variable; VOL/BAL
RV551		
RV503,504	1-226-231-00	(D) 100k/100k, variable; BASS/TREBLE
RV553,554		
FR201, 202	(A)1-212-881-00	(B) 100 $\frac{1}{4}$ W fusible
FR301	1-212-994-00	(A) 330 $\frac{1}{2}$ W fusible
FR601, 602	1-212-958-00	(B) 10 $\frac{1}{2}$ W fusible
FR651, 652		
FR614	1-213-147-00	(A) 2.2k 1W fusible
FR801, 802	(A)1-212-982-00	(B) 100 $\frac{1}{2}$ W fusible
FR803	(A)1-213-036-00	(B) 1 1W fusible
FR903, 953	(A)1-247-228-00	(A) 330 $\frac{1}{2}$ W (nonflammable)

SWITCHES

S1	1-553-063-00	(G) Pushbutton, FUNCTION
S2, 3, 4	1-553-062-00	(D) Pushbutton, MODE/HI-FILTER/LOUDNESS
S5	1-553-066-00	(F) Rotary-slide, BAND SELECT
S6	1-553-061-00	(K) Pushbutton, PROGRAMMED TUNING
S7, 8	1-553-065-00	(C) Pushbutton, PROGRAM
S9	(A)1-552-601-00	(G) Rotary, SPEAKERS
S10	1-552-233-00	(C) Pushbutton, ANTENNA

MISCELLANEOUS

CF201	1-527-534-93	(D) Filter
CNJ901,902	(A)1-526-636-00	(E) AC Outlet (AEP, UK model)
CP803,804	(A)1-102-394-00	(B) 0.01 + 0.01 μ F 250V ceramic
CP901	(A)1-130-196-00	(D) 0.01 μ F
CP902	(A)1-130-196-00	(D) 0.01 μ F (SCN model)

Ref. No. Part No. Description

FB901	(A)1-532-534-00	(C) Circuit Breaker
FE	1-463-289-00	(M) Front End
FIP901	1-519-189-00	(M) Fluorescent Indicator Lamp
J901, 951	1-507-637-21	(C) Jack, 6P; PHONO TAPE 1
J902, 952		
J904, 954		
J903, 953	1-507-629-00	(E) Jack, 4P; TAPE 2
J905, 955		
J906	1-507-659-00	(C) Jack, HEADPHONES
MF202	1-527-403-00	(C) Mechanical Filter
PL901, 902	1-518-395-00	(B) Lamp, 8V 300mA
PTH601	1-800-427-00	(B) Thermistor, positive
RY601	1-515-356-00	(F) Relay
TM901-903	1-536-524-00	(C) Terminal, 4P; SPEAKER A/B, ANTENNA
XT301	1-527-533-00	(D) Crystal
	(A)1-551-896-00	(E) Cord, power; 3P (AEP model)
	(A)1-551-908-00	(E) Cord, power; 3P (SCN model)
	(A)1-551-962-00	(E) Cord, power; 3P (UK model)
	(A)1-551-966-00	(G) Cord, power; 2P (AEP model)
	(A)1-551-967-00	(E) Cord, power; 2P (UK model)
	1-601-293-00	(B) Printed Circuit Board, IC

Note: The components identified by shading and mark **(A)** are critical for safety. Replace only with part number specified.

ACCESSORIES AND PACKING MATERIALS

<u>Part No.</u>	<u>Description</u>
1-501-184-00	(C) Feeder Antenna
1-501-193-00	(B) Antenna
3-701-630-00	(A) Bag, plastic
3-770-953-11	(F) Manual, instruction
4-809-251-00	(A) Bag, plastic
4-864-402-00	(B) Cushion, lower
4-864-403-00	(B) Cushion, upper left
4-864-404-00	(B) Cushion, upper right
4-864-463-00	(E) Carton

ELECTROLYTIC CAPACITORS

Note: Circled letter (A to Z) are applicable to European models only.

CAP. (μF)	RATING → : Use the high voltage rated one.					
	6.3 VOLT.	10 VOLT.	16 VOLT.	25 VOLT.	35 VOLT.	50 VOLT.
	PART No.	PART No.	PART No.	PART No.	PART No.	PART No.
0.47						1-121-726-00 (A)
1.0						1-121-391-00 (A)
2.2						1-121-450-00 (A)
3.3	→	→	→	1-121-392-00 (A)	→	1-121-393-00 (A)
4.7	→	→	→	1-121-395-00 (A)	→	1-121-396-00 (A)
10	→	→	1-121-651-00 (A)	1-121-398-00 (A)	→	1-121-738-00 (A)
22	→	→	1-121-479-00 (A)	1-121-480-00 (A)	1-121-662-00 (A)	1-121-152-00 (A)
33	→	→	1-121-403-00 (A)	1-121-404-00 (A)	1-121-652-00 (B)	1-121-405-00 (A)
47	→	1-121-352-00 (A)	1-121-409-00 (A)	1-121-410-00 (A)	1-121-653-00 (B)	1-121-411-00 (A)
100	→	1-121-414-00 (A)	1-121-415-00 (A)	1-121-416-00 (A)	1-121-357-00 (B)	1-121-417-00 (B)
220	1-121-419-00 (B)	1-121-420-00 (B)	1-121-421-00 (A)	1-121-422-00 (B)	1-121-261-00 (C)	1-121-423-00 (B)
330	1-121-751-00 (B)	1-121-805-00 (B)	1-121-521-00 (C)	1-121-654-00 (B)	1-121-655-00 (D)	1-121-656-00 (C)
470	1-121-424-00 (B)	1-121-425-00 (C)	1-121-426-00 (C)	1-121-733-00 (B)	1-121-361-00 (E)	1-121-810-00 (D)
1000	-	1-121-736-00 (C)	1-121-245-00 (D)	1-121-657-00 (D)	1-121-388-00 (E)	1-123-061-00 (F)
2200	1-121-658-00 (B)	1-121-659-00 (C)	1-121-660-00 (D)	1-123-067-00 (F)	1-121-984-00 (F)	-
3300	1-121-661-00 (D)	1-123-075-00 (E)	1-123-071-00 (F)	-	-	-

CAP. (μF)	100 VOLT.	160 VOLT.	250 VOLT.	350 VOLT.
	PART No.	PART No.	PART No.	PART No.
0.47	-	-	-	-
1.0	1-123-249-00 (A)	1-123-252-00 (A)	1-123-003-00 (B)	1-121-168-00 (B)
2.2	1-123-250-00 (A)	1-123-026-00 (B)	-	1-123-028-00 (B)
3.3	1-121-995-00 (A)	-	1-123-004-00 (B)	1-123-006-00 (C)
4.7	1-123-255-00 (A)	1-121-246-00 (B)	1-121-759-00 (B)	1-123-007-00 (D)
10	1-121-126-00 (B)	1-121-999-00 (B)	1-123-254-00 (C)	1-123-008-00 (D)
22	1-121-996-00 (C)	1-123-253-00 (C)	1-123-005-00 (D)	1-123-022-00 (D)
33	1-121-997-00 (C)	1-121-757-00 (C)	-	-
47	1-123-251-00 (C)	1-121-919-00 (C)	-	-
100	1-123-084-00 (E)	-	-	-

CERAMIC CAPACITORS (A)

CAP. (pF)	RATING						
	50 VOLT.	CAP. (pF)	50 VOLT.	CAP. (pF)	50 VOLT.	CAP. (μF)	50 VOLT.
	PART No.		PART No.		PART No.		PART No.
0.5	1-101-837-00	22	1-102-959-00	150	1-101-361-00	0.001	1-102-074-00
0.75	1-101-586-00	24	1-102-960-00	160	1-101-367-00	0.0012	1-102-118-00
1.0	1-102-934-00	27	1-102-961-00	180	1-102-976-00	0.0015	1-102-119-00
1.5	1-101-576-00	30	1-102-962-00	200	1-102-977-00	0.0018	1-102-120-00
2.0	1-102-935-00	33	1-102-963-00	220	1-102-978-00	0.0022	1-102-121-00
3	1-102-936-00	36	1-102-964-00	240	1-102-979-00	0.0027	1-102-122-00
4	1-102-937-00	39	1-102-965-00	270	1-102-980-00	0.0033	1-102-123-00
5	1-102-942-00	43	1-102-966-00	300	1-102-981-00	0.0039	1-102-124-00
6	1-102-943-00	47	1-101-880-00	330	1-102-820-00	0.0047	1-102-125-00
7	1-102-944-00	51	1-101-882-00	360	1-102-821-00	0.0056	1-102-126-00
8	1-102-945-00	56	1-101-884-00	390	1-102-822-00	0.0068	1-102-127-00
9	1-102-946-00	62	1-101-886-00	430	1-102-823-00	0.0082	1-102-128-00
10	1-102-947-00	68	1-101-888-00	470	1-102-824-00	0.01	1-102-129-00
11	1-102-948-00	75	1-101-890-00	510	1-101-059-00	0.022	1-101-005-00
12	1-102-949-00	82	1-102-971-00	560	1-102-115-00	0.047	1-101-006-00
13	1-102-950-00	91	1-102-972-00	680	1-102-116-00		
15	1-102-951-00	100	1-102-973-00	820	1-102-117-00		
16	1-102-952-00	110	1-102-815-00				
18	1-102-953-00	120	1-102-816-00				
20	1-102-958-00	130	1-101-081-00				

0.001μF = 1,000pF

CERAMIC (SEMICONDUCTOR) CAPACITORS (A)

CAP. (μF)	RATING → : Use the high voltage rated one.				
	25 VOLT.	50 VOLT.	CAP. (μF)	25 VOLT.	50 VOLT.
	PART No.	PART No.		PART No.	PART No.
0.001	→	1-161-039-00	0.018	1-161-016-00	1-161-054-00
0.0012	→	1-161-040-00	0.022	1-161-017-00	1-161-055-00
0.0015		1-161-041-00	0.027	1-161-018-00	1-161-056-00
0.0018		1-161-042-00	0.033	1-161-019-00	1-161-057-00
0.0022		1-161-043-00	0.039	1-161-010-00	1-161-058-00
0.0027	→	1-161-044-00	0.047	1-161-021-00	1-161-059-00
0.0033	→	1-161-045-00	0.056	→	1-161-060-00
0.0039	→	1-161-046-00	0.068	→	1-161-061-00
0.0047	→	1-161-047-00	0.082	1-161-024-00	1-161-062-00
0.0056	→	1-161-048-00	0.1	1-161-025-00	1-161-063-00
0.0068	→	1-161-049-00			
0.0082	1-161-012-00	1-161-050-00			
0.01	1-161-013-00	1-161-051-00			
0.012	→	1-161-052-00			
0.015	1-161-015-00	1-161-053-00			

MYLAR CAPACITORS (A)

Note: Circled letters (A) to (Z) are applicable to European models only.

RATING											
CAP. (μF)	50 VOLT.	100 VOLT.	200 VOLT.	CAP. (μF)	50 VOLT.	100 VOLT.	200 VOLT.	CAP. (μF)	50 VOLT.	100 VOLT.	200 VOLT.
	PART No.	PART No.	PART No.		PART No.	PART No.	PART No.		PART No.	PART No.	PART No.
0.001	1-108-227-00	1-108-365-00	1-108-409-00	0.01	1-108-239-00	1-108-377-00	1-108-421-00	0.1	1-108-251-00	1-108-389-00	1-108-433-00
0.0012	1-108-351-00	1-108-366-00	1-108-410-00	0.012	1-108-357-00	1-108-378-00	1-108-422-00	0.12	1-108-363-00	1-108-390-00	1-108-434-00
0.0015	1-108-228-00	1-108-367-00	1-108-411-00	0.015	1-108-240-00	1-108-379-00	1-108-423-00	0.15	1-108-252-00	1-108-391-00	1-108-435-00
0.0018	1-108-352-00	1-108-368-00	1-108-412-00	0.018	1-108-358-00	1-108-380-00	1-108-424-00	0.18	1-108-364-00	1-108-392-00	1-108-436-00
0.0022	1-108-230-00	1-108-369-00	1-108-413-00	0.022	1-108-242-00	1-108-381-00	1-108-425-00	0.22	1-108-254-00	1-108-393-00	1-108-437-00
0.0027	1-108-353-00	1-108-370-00	1-108-414-00	0.027	1-108-359-00	1-108-382-00	1-108-426-00	0.27	1-108-854-00	-	-
0.0033	1-108-232-00	1-108-371-00	1-108-415-00	0.033	1-108-244-00	1-108-383-00	1-108-427-00	0.33	1-108-855-00	-	-
0.0039	1-108-354-00	1-108-372-00	1-108-416-00	0.039	1-108-360-00	1-108-384-00	1-108-428-00	0.39	1-108-856-00	-	-
0.0047	1-108-234-00	1-108-373-00	1-108-417-00	0.047	1-108-246-00	1-108-385-00	1-108-429-00	0.47	1-108-857-00	-	-
0.0056	1-108-355-00	1-108-374-00	1-108-418-00	0.056	1-108-361-00	1-108-386-00	1-108-430-00	-	-	-	-
0.0068	1-108-237-00	1-108-375-00	1-108-419-00	0.068	1-108-249-00	1-108-387-00	1-108-431-00	-	-	-	-
0.0082	1-108-356-00	1-108-376-00	1-108-420-00	0.082	1-108-362-00	1-108-388-00	1-108-432-00	-	-	-	-

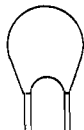

TANTALUM CAPACITORS

RATING → : Use the high voltage rated one.							
CAP. (μF)	3.15 VOLT.	6.3 VOLT.	10 VOLT.	16 VOLT.	20 VOLT.	25 VOLT.	35 VOLT.
	PART No.	PART No.	PART No.	PART No.	PART No.	PART No.	PART No.
0.01					→	→	1-131-396-00 (B)
0.015						→	1-131-397-00 (B)
0.022						→	1-131-398-00 (B)
0.033						→	1-131-399-00 (B)
0.047						→	1-131-400-00 (B)
0.068					→	→	1-131-401-00 (B)
0.1					→	→	1-131-402-00 (B)
0.15					→	→	1-131-403-00 (B)
0.22					→	→	1-131-404-00 (B)
0.33					→	1-131-409-00 (B)	1-131-405-00 (B)
0.47	-	-	-	-	1-131-412-00 (B)	→	1-131-406-00 (B)
0.68	-	-	-	1-131-415-00 (B)	→	1-131-410-00 (B)	1-131-407-00 (B)
1.0	-	-	1-131-418-00 (B)	-	1-131-413-00 (B)	→	1-131-408-00 (B)
1.5	-	1-131-421-00 (B)	-	1-131-416-00 (B)	→	1-131-411-00 (B)	1-131-348-00 (B)
2.2	1-131-424-00 (B)	-	1-131-419-00 (B)	-	1-131-414-00 (B)	1-131-355-00 (B)	1-131-349-00 (B)
3.3	-	1-131-422-00 (B)	-	1-131-417-00 (B)	1-131-362-00 (B)	1-131-356-00 (B)	1-131-350-00 (B)
4.7	1-131-425-00 (B)	-	1-131-420-00 (B)	1-131-369-00 (B)	1-131-363-00 (B)	1-131-357-00 (B)	1-131-351-00 (C)
6.8	-	1-131-423-00 (B)	1-131-376-00 (B)	1-131-370-00 (B)	1-131-364-00 (B)	1-131-358-00 (C)	1-131-352-00 (C)
10	1-131-426-00 (B)	1-131-383-00 (B)	1-131-377-00 (B)	1-131-371-00 (B)	1-131-365-00 (C)	1-131-359-00 (C)	1-131-353-00 (D)
15	1-131-390-00 (D)	1-131-384-00 (B)	1-131-378-00 (B)	1-131-372-00 (B)	1-131-366-00 (C)	1-131-360-00 (D)	-
22	1-131-391-00 (B)	1-131-385-00 (B)	1-131-379-00 (C)	1-131-373-00 (C)	1-131-367-00 (D)	-	-
33	1-131-392-00 (B)	1-131-386-00 (C)	1-131-380-00 (C)	1-131-374-00 (D)	-	-	-
47	1-131-393-00 (C)	1-131-387-00 (C)	1-131-381-00 (D)	-	-	-	-
68	1-131-394-00 (D)	1-131-388-00 (C)	-	-	-	-	-
100	1-131-395-00 (B)	-	-	-	-	-	-



TANTALUM CAPACITORS

RATING						
CAP. (μF)	3 VOLT.	6.3 VOLT.	10 VOLT.	16 VOLT.	20 VOLT.	35 VOLT.
	PART No.	PART No.	PART No.	PART No.	PART No.	PART No.
0.033						1-131-273-00 (E)
0.047						1-131-274-00 (E)
0.068						1-131-275-00 (E)
0.1						1-131-276-00 (E)
0.15						1-131-277-00 (D)
0.22					1-131-262-00 (D)	1-131-278-00 (D)
0.33					1-131-263-00 (D)	1-131-279-00 (D)
0.47			1-131-169-00 (D)		1-131-264-00 (D)	1-131-280-00 (D)
0.68				1-131-258-00 (D)	1-131-265-00 (D)	1-131-281-00 (D)
1.0			1-131-254-00 (D)		1-131-266-00 (D)	1-131-282-00 (D)
1.5		1-131-250-00 (D)			1-131-267-00 (D)	1-131-283-00 (E)
2.2				1-131-259-00 (D)	1-131-268-00 (D)	1-131-284-00 (E)
3.3					1-131-269-00 (D)	-
4.7		1-131-251-00 (E)	1-131-255-00 (D)		1-131-270-00 (D)	-
6.8			1-131-171-00 (D)		1-131-271-00 (E)	-
10				1-131-256-00 (D)	1-131-272-00 (E)	-
15		1-131-252-00 (D)		1-131-261-00 (E)	-	-
22					-	-
33	1-131-176-00 (B)	1-131-253-00 (E)	1-131-257-00 (E)		-	-
47	1-131-288-00 (F)	1-131-174-00 (D)	1-131-173-00 (C)		-	-
100	1-131-177-00 (D)				-	-

1/4 WATT CARBON RESISTORS [Ⓐ]

Note: Circled letter [Ⓐ] is applicable to European models only.

Ω	Part No.	Ω	Part No.	Ω	Part No.	Ω	Part No.	Ω	Part No.	Ω	Part No.	Ω	Part No.
1.0	1-246-401-00	10	1-246-425-00	100	1-246-449-00	1.0k	1-246-473-00	10k	1-246-497-00	100k	1-246-521-00	1.0M	1-246-545-00
1.1	1-246-402-00	11	1-246-426-00	110	1-246-450-00	1.1k	1-246-474-00	11k	1-246-498-00	110k	1-246-522-00	1.1M	1-210-814-00
1.2	1-246-403-00	12	1-246-427-00	120	1-246-451-00	1.2k	1-246-475-00	12k	1-246-499-00	120k	1-246-523-00	1.2M	1-210-815-00
1.3	1-246-404-00	13	1-246-428-00	130	1-246-452-00	1.3k	1-246-476-00	13k	1-246-500-00	130k	1-246-524-00	1.3M	1-210-816-00
1.5	1-246-405-00	15	1-246-429-00	150	1-246-453-00	1.5k	1-246-477-00	15k	1-246-501-00	150k	1-246-525-00	1.5M	1-210-817-00
1.6	1-246-406-00	16	1-246-430-00	160	1-246-454-00	1.6k	1-246-478-00	16k	1-246-502-00	160k	1-246-526-00	1.6M	1-210-818-00
1.8	1-246-407-00	18	1-246-431-00	180	1-246-455-00	1.8k	1-246-479-00	18k	1-246-503-00	180k	1-246-527-00	1.8M	1-210-819-00
2.0	1-246-408-00	20	1-246-432-00	200	1-246-456-00	2.0k	1-246-480-00	20k	1-246-504-00	200k	1-246-528-00	2.0M	1-210-820-00
2.2	1-246-409-00	22	1-246-433-00	220	1-246-457-00	2.2k	1-246-481-00	22k	1-246-505-00	220k	1-246-529-00	2.2M	1-210-821-00
2.4	1-246-410-00	24	1-246-434-00	240	1-246-458-00	2.4k	1-246-482-00	24k	1-246-506-00	240k	1-246-530-00	2.4M	1-244-754-00
2.7	1-246-411-00	27	1-246-435-00	270	1-246-459-00	2.7k	1-246-483-00	27k	1-246-507-00	270k	1-246-531-00	2.7M	1-244-755-00
3.0	1-246-412-00	30	1-246-436-00	300	1-246-460-00	3.0k	1-246-484-00	30k	1-246-508-00	300k	1-246-532-00	3.0M	1-244-756-00
3.3	1-246-413-00	33	1-246-437-00	330	1-246-461-00	3.3k	1-246-485-00	33k	1-246-509-00	330k	1-246-533-00	3.3M	1-244-757-00
3.6	1-246-414-00	36	1-246-438-00	360	1-246-462-00	3.6k	1-246-486-00	36k	1-246-510-00	360k	1-246-534-00	3.6M	1-244-758-00
3.9	1-246-415-00	39	1-246-439-00	390	1-246-463-00	3.9k	1-246-487-00	39k	1-246-511-00	390k	1-246-535-00	3.9M	1-244-759-00
4.3	1-246-416-00	43	1-246-440-00	430	1-246-464-00	4.3k	1-246-488-00	43k	1-246-512-00	430k	1-246-536-00	4.3M	1-244-760-00
4.7	1-246-417-00	47	1-246-441-00	470	1-246-465-00	4.7k	1-246-489-00	47k	1-246-513-00	470k	1-246-537-00	4.7M	1-244-761-00
5.1	1-246-418-00	51	1-246-442-00	510	1-246-466-00	5.1k	1-246-490-00	51k	1-246-514-00	510k	1-246-538-00	5.1M	1-244-762-00
5.6	1-246-419-00	56	1-246-443-00	560	1-246-467-00	5.6k	1-246-491-00	56k	1-246-515-00	560k	1-246-539-00		
6.2	1-246-420-00	62	1-246-444-00	620	1-246-468-00	6.2k	1-246-492-00	62k	1-246-516-00	620k	1-246-540-00		
6.8	1-246-421-00	68	1-246-445-00	680	1-246-469-00	6.8k	1-246-493-00	68k	1-246-517-00	680k	1-246-541-00		
7.5	1-246-422-00	75	1-246-446-00	750	1-246-470-00	7.5k	1-246-494-00	75k	1-246-518-00	750k	1-246-542-00		
8.2	1-246-423-00	82	1-246-447-00	820	1-246-471-00	8.2k	1-246-495-00	82k	1-246-519-00	820k	1-246-543-00		
9.1	1-246-424-00	91	1-246-448-00	910	1-246-472-00	9.1k	1-246-496-00	91k	1-246-520-00	910k	1-246-544-00		

HARDWARE NOMENCLATURE

Screw:

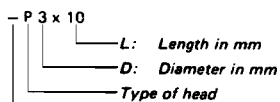

Indicated slotted-head only.
Unless otherwise indicated, it means cross-recessed head (Phillips type).

Nut, Washer, Retaining ring:

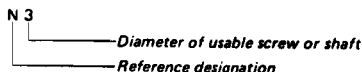

Reference Designation	Shape	Description	Remarks
SCREWS			
P		pan-head screw	binding-head (B) screw for replacement
PWH		pan-head screw with washer face	binding-head (B) screw and flat washer for replacement
PS PSP		pan-head screw with spring washer	binding-head (B) screw and spring washer for replacement
PSW PSPW		pan-head screw with spring and flat washers	binding-head (B) screw and spring and flat washers for replacement
R		round-head screw	binding-head (B) screw for replacement
K		flat-countersunk-head screw	
RK		oval-countersunk-head screw	
B		binding-head screw	
T		truss-head screw	binding-head (B) screw for replacement
F		flat-fillister-head screw	
RF		fillister-head screw	
BV		braizer-head screw	

Reference Designation	Shape	Description	Remarks
SELF-TAPPING SCREWS			
TA		self-tapping screw	ex: TA, P 3 x 10
PTP		pan-head self-tapping screw	binding-head self-tapping (TA, B) screw for replacement
PTPWH		pan-head self-tapping screw with washer face	binding-head self-tapping (TA, B) screw and flat washer for replacement
PTTWH		pan-head thread-rolling screw with washer face	binding-head (B) screw and flat washer for replacement
SET SCREWS			
SC		set screw	
SC		hexagon-socket set screw	ex: SC 2.6 x 4, hexagon socket
NUT			
N		nut	
WASHERS			
W		flat washer	
SW		spring washer	
LW		internal-tooth lock washer	ex: LW3, internal
LW		external-tooth lock washer	ex: LW3, external
RETAINING RINGS			
E		retaining ring	
G		grip-type retaining ring	

AEP Model
UK Model
SCN Model

SUPPLEMENT

File this supplement with the service manual.

No. 1
December 1979

PRODUCTION CHANGE

COUNTER and EQ BOARD

AEP Model

Serial No. 505701 and later

UK Model

Serial No. 600501 and later

SCN Model

Serial No. 550001 and later

TUNER BOARD

AEP Model

Serial No. 505801 and later

UK Model

Serial No. 601501 and later

SCN Model

Serial No. 550001 and later

MOUNTING DIAGRAM

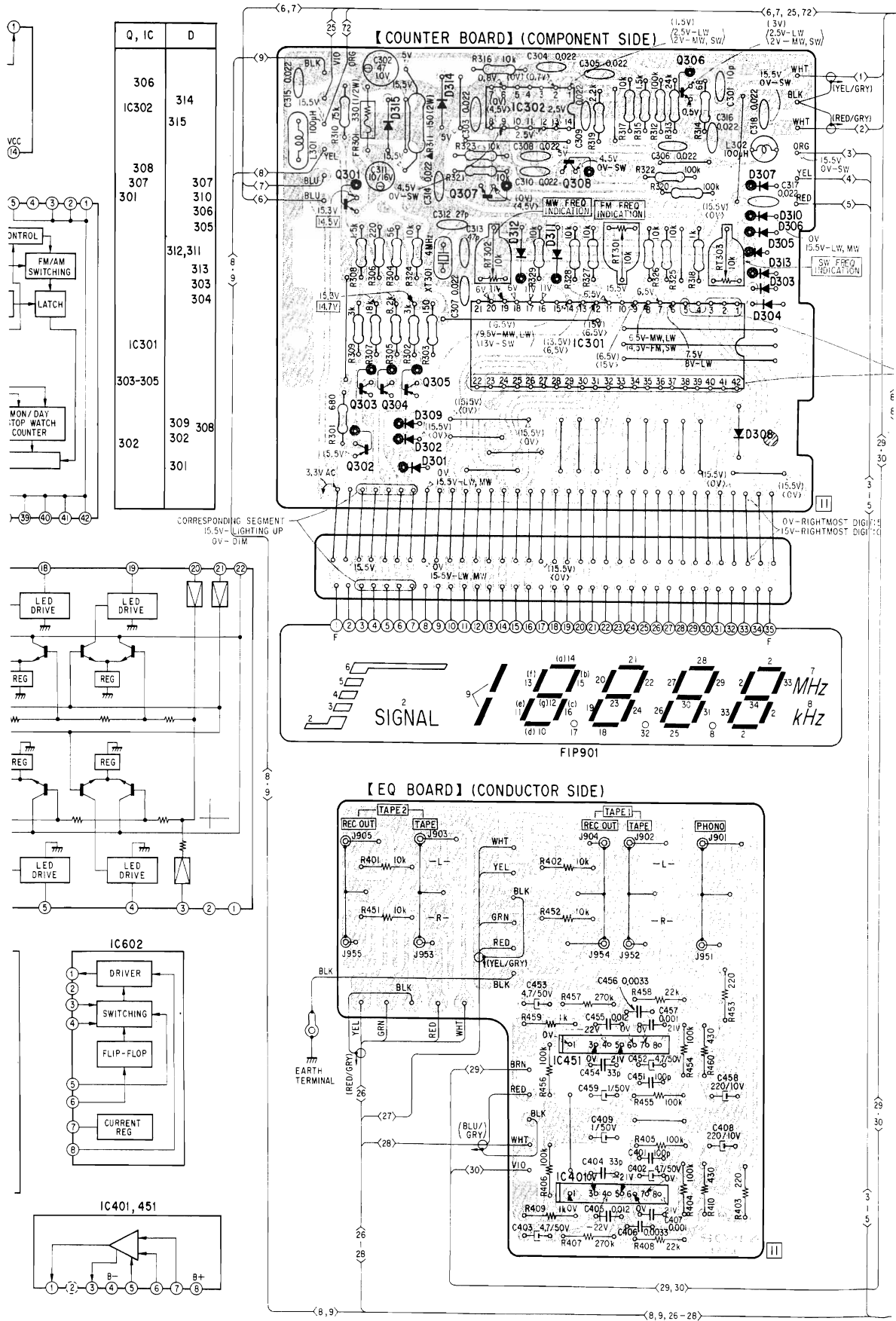

STR-434L STR-434L

Scanned

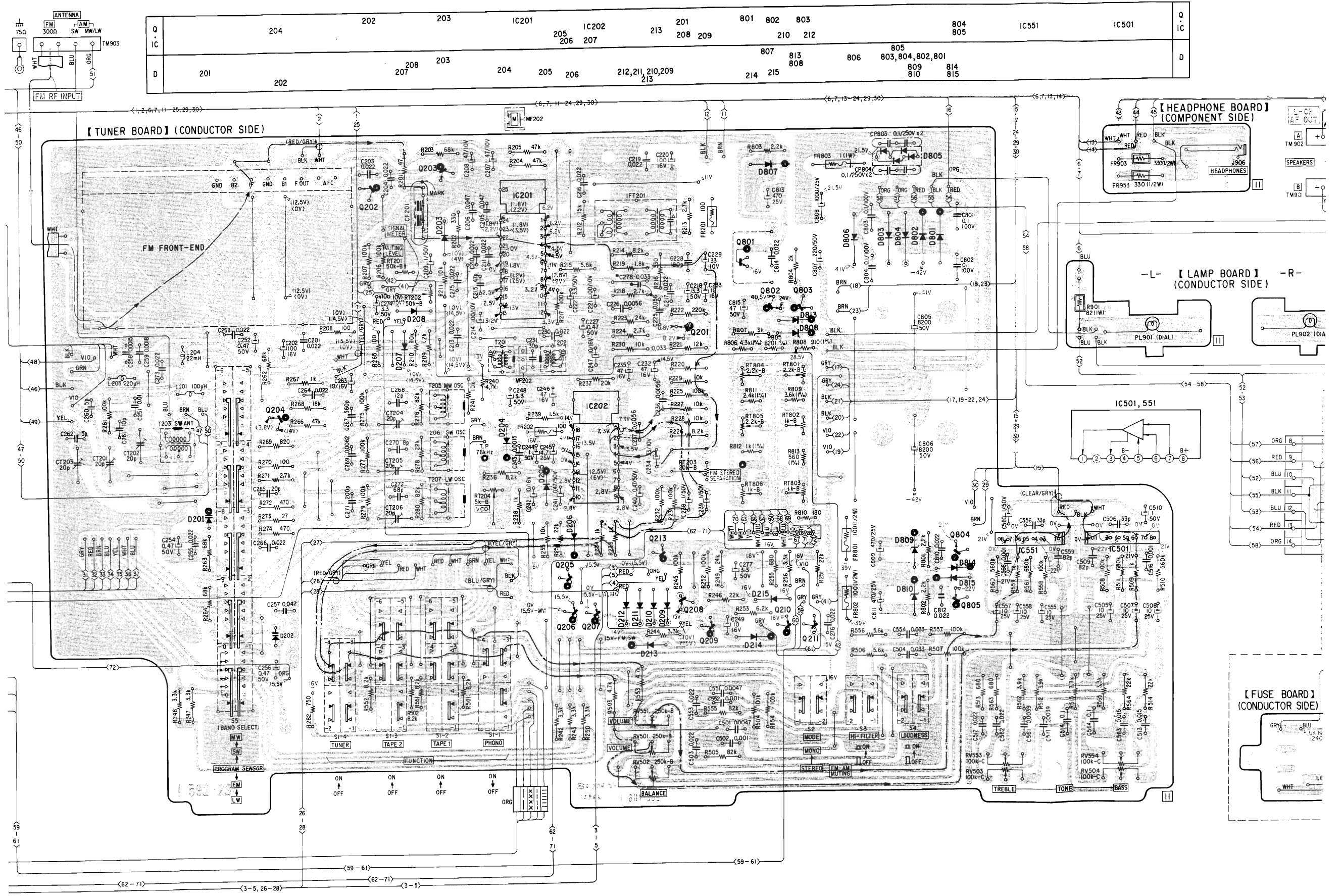

Q	204	202	203	IC201	205	IC202	213	201	801	802	803	804	IC551	IC501	Q	
IC					206	207		208	210	212		805			IC	
D	201	202	207	208	203	204	205	206	212, 211, 210, 209, 213	214	215	806	803, 804, 802, 801	809	814	D
												810	815			

SCHEMATIC DIAGRAM

